



Himel

Reliable made affordable.



Fiyat Listesi
Haziran 2022

Himel

Reliable made affordable.



- * Her hangi bir yazılı bildirimde bulunmaksızın fiyatlarımızda deęişiklik yapma hakkımız saklıdır.
- * Faturalamada teslim tarihindeki liste fiyatları geçerlidir.
- * Liste dışı malzemelerimiz için yetkili satıcılarımız ya da bölge sorumlularımıza müracaat ediniz.
- * Fiyatlarımıza KDV dahil deęildir.
- * Baskı ve tipografik hatalardan firmamız sorumlu deęildir.



İçindekiler

Otomatik Sigortalar	2 - 7
Kaçak Akım Koruma Röleleri	8
Kompakt Şalterler	9 - 23
Açık Tip Güç Şalterleri	24 - 26
Yangın Korumalı Kompakt Şalterler	27 - 28
Silindirik Sigortalar	29
Kontaktör ve Termik Röleler	30 - 41
Motor Koruma Şalterleri	42
Butonlar ve Sinyal Lambaları	43
Himel Türkiye ve Yetkili İş Ortakları	44



Kutup Sayısı	Anma Akımı (A)	B Eğrisi Referans Kodu	C Eğrisi Referans Kodu	Birim Fiyat (₺)	Kutu (Adet)	Koli (Adet)
1 Kutup	1A	HDB3WHL1B1	HDB3WHL1C1	75,00	12	144
1 Kutup	2A	HDB3WHL1B2	HDB3WHL1C2	75,00	12	144
1 Kutup	3A	HDB3WHL1B3	HDB3WHL1C3	75,00	12	144
1 Kutup	4A	HDB3WHL1B4	HDB3WHL1C4	75,00	12	144
1 Kutup	6A	HDB3WHL1B6	HDB3WHL1C6	64,00	12	144
1 Kutup	10A	HDB3WHL1B10	HDB3WHL1C10	58,00	12	144
1 Kutup	16A	HDB3WHL1B16	HDB3WHL1C16	58,00	12	144
1 Kutup	20A	HDB3WHL1B20	HDB3WHL1C20	58,00	12	144
1 Kutup	25A	HDB3WHL1B25	HDB3WHL1C25	58,00	12	144
1 Kutup	32A	HDB3WHL1B32	HDB3WHL1C32	75,00	12	144
1 Kutup	40A	HDB3WHL1B40	HDB3WHL1C40	77,00	12	144
1 Kutup	50A	HDB3WHL1B50	HDB3WHL1C50	90,00	12	144
1 Kutup	63A	HDB3WHL1B63	HDB3WHL1C63	94,00	12	144



2 Kutup	2A	HDB3WHL2B2	HDB3WHL2C2	166,00	6	72
2 Kutup	3A	HDB3WHL2B3	HDB3WHL2C3	166,00	6	72
2 Kutup	6A	HDB3WHL2B6	HDB3WHL2C6	166,00	6	72
2 Kutup	10A	HDB3WHL2B10	HDB3WHL2C10	153,00	6	72
2 Kutup	16A	HDB3WHL2B16	HDB3WHL2C16	153,00	6	72
2 Kutup	20A	HDB3WHL2B20	HDB3WHL2C20	153,00	6	72
2 Kutup	25A	HDB3WHL2B25	HDB3WHL2C25	153,00	6	72
2 Kutup	32A	HDB3WHL2B32	HDB3WHL2C32	173,00	6	72
2 Kutup	40A	HDB3WHL2B40	HDB3WHL2C40	179,00	6	72
2 Kutup	50A	HDB3WHL2B50	HDB3WHL2C50	190,00	6	72
2 Kutup	63A	HDB3WHL2B63	HDB3WHL2C63	190,00	6	72



3 Kutup	2A	HDB3WHL3B2	HDB3WHL3C2	258,00	4	48
3 Kutup	3A	HDB3WHL3B3	HDB3WHL3C3	258,00	4	48
3 Kutup	6A	HDB3WHL3B6	HDB3WHL3C6	258,00	4	48
3 Kutup	10A	HDB3WHL3B10	HDB3WHL3C10	215,00	4	48
3 Kutup	16A	HDB3WHL3B16	HDB3WHL3C16	215,00	4	48
3 Kutup	20A	HDB3WHL3B20	HDB3WHL3C20	215,00	4	48
3 Kutup	25A	HDB3WHL3B25	HDB3WHL3C25	215,00	4	48
3 Kutup	32A	HDB3WHL3B32	HDB3WHL3C32	236,00	4	48
3 Kutup	40A	HDB3WHL3B40	HDB3WHL3C40	245,00	4	48
3 Kutup	50A	HDB3WHL3B50	HDB3WHL3C50	277,00	4	48
3 Kutup	63A	HDB3WHL3B63	HDB3WHL3C63	311,00	4	48



4 Kutup	2A	HDB3WHL4B2	HDB3WHL4C2	328,00	3	36
4 Kutup	3A	HDB3WHL4B3	HDB3WHL4C3	328,00	3	36
4 Kutup	6A	HDB3WHL4B6	HDB3WHL4C6	328,00	3	36
4 Kutup	10A	HDB3WHL4B10	HDB3WHL4C10	302,00	3	36
4 Kutup	16A	HDB3WHL4B16	HDB3WHL4C16	302,00	3	36
4 Kutup	20A	HDB3WHL4B20	HDB3WHL4C20	302,00	3	36
4 Kutup	25A	HDB3WHL4B25	HDB3WHL4C25	302,00	3	36
4 Kutup	32A	HDB3WHL4B32	HDB3WHL4C32	321,00	3	36
4 Kutup	40A	HDB3WHL4B40	HDB3WHL4C40	334,00	3	36
4 Kutup	50A	HDB3WHL4B50	HDB3WHL4C50	372,00	3	36
4 Kutup	63A	HDB3WHL4B63	HDB3WHL4C63	423,00	3	36

Kutup Sayısı	Anma Akımı (A)	B Eğrisi Referans Kodu	C Eğrisi Referans Kodu	Birim Fiyat (₺)	Kutu (Adet)	Koli (Adet)
1 Kutup	1 A	HDB3wHN1B1	HDB3wHN1C1	78,00	12	144
1 Kutup	2 A	HDB3wHN1B2	HDB3wHN1C2	78,00	12	144
1 Kutup	3 A	HDB3wHN1B3	HDB3wHN1C3	80,00	12	144
1 Kutup	4 A	HDB3wHN1B4	HDB3wHN1C4	80,00	12	144
1 Kutup	6 A	HDB3wHN1B6	HDB3wHN1C6	74,00	12	144
1 Kutup	10 A	HDB3wHN1B10	HDB3wHN1C10	64,00	12	144
1 Kutup	16 A	HDB3wHN1B16	HDB3wHN1C16	64,00	12	144
1 Kutup	20 A	HDB3wHN1B20	HDB3wHN1C20	64,00	12	144
1 Kutup	25 A	HDB3wHN1B25	HDB3wHN1C25	64,00	12	144
1 Kutup	32 A	HDB3wHN1B32	HDB3wHN1C32	74,00	12	144
1 Kutup	40 A	HDB3wHN1B40	HDB3wHN1C40	86,00	12	144
1 Kutup	50 A	HDB3wHN1B50	HDB3wHN1C50	104,00	12	144
1 Kutup	63 A	HDB3wHN1B63	HDB3wHN1C63	110,00	12	144
2 Kutup	2 A	HDB3wHN2B2	HDB3wHN2C2	226,00	6	72
2 Kutup	6 A	HDB3wHN2B6	HDB3wHN2C6	183,00	6	72
2 Kutup	10 A	HDB3wHN2B10	HDB3wHN2C10	183,00	6	72
2 Kutup	16 A	HDB3wHN2B16	HDB3wHN2C16	183,00	6	72
2 Kutup	20 A	HDB3wHN2B20	HDB3wHN2C20	183,00	6	72
2 Kutup	25 A	HDB3wHN2B25	HDB3wHN2C25	183,00	6	72
2 Kutup	32 A	HDB3wHN2B32	HDB3wHN2C32	202,00	6	72
2 Kutup	40 A	HDB3wHN2B40	HDB3wHN2C40	219,00	6	72
2 Kutup	50 A	HDB3wHN2B50	HDB3wHN2C50	228,00	6	72
2 Kutup	63 A	HDB3wHN2B63	HDB3wHN2C63	234,00	6	72
3 Kutup	2 A	HDB3wHN3B2	HDB3wHN3C2	295,00	4	48
3 Kutup	6 A	HDB3wHN3B6	HDB3wHN3C6	239,00	4	48
3 Kutup	10 A	HDB3wHN3B10	HDB3wHN3C10	239,00	4	48
3 Kutup	16 A	HDB3wHN3B16	HDB3wHN3C16	239,00	4	48
3 Kutup	20 A	HDB3wHN3B20	HDB3wHN3C20	239,00	4	48
3 Kutup	25 A	HDB3wHN3B25	HDB3wHN3C25	239,00	4	48
3 Kutup	32 A	HDB3wHN3B32	HDB3wHN3C32	265,00	4	48
3 Kutup	40 A	HDB3wHN3B40	HDB3wHN3C40	271,00	4	48
3 Kutup	50 A	HDB3wHN3B50	HDB3wHN3C50	284,00	4	48
3 Kutup	63 A	HDB3wHN3B63	HDB3wHN3C63	293,00	4	48
4 Kutup	2 A	HDB3wHN4B2	HDB3wHN4C2	419,00	3	36
4 Kutup	6 A	HDB3wHN4B6	HDB3wHN4C6	400,00	3	36
4 Kutup	10 A	HDB3wHN4B10	HDB3wHN4C10	311,00	3	36
4 Kutup	16 A	HDB3wHN4B16	HDB3wHN4C16	311,00	3	36
4 Kutup	20 A	HDB3wHN4B20	HDB3wHN4C20	311,00	3	36
4 Kutup	25 A	HDB3wHN4B25	HDB3wHN4C25	311,00	3	36
4 Kutup	32 A	HDB3wHN4B32	HDB3wHN4C32	332,00	3	36
4 Kutup	40 A	HDB3wHN4B40	HDB3wHN4C40	374,00	3	36
4 Kutup	50 A	HDB3wHN4B50	HDB3wHN4C50	415,00	3	36
4 Kutup	63 A	HDB3wHN4B63	HDB3wHN4C63	461,00	3	36



Teknik Özellikler

Boyutlar Birim: mm

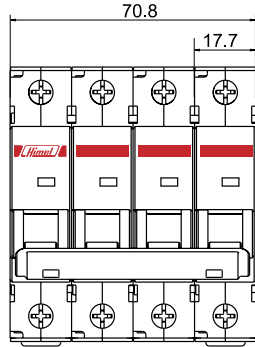
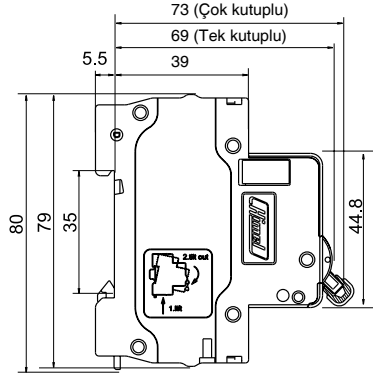

Otomatik Sigorta	HDB3wH 18mm Devre Kesici			
Standart	IEC 60898-1			
Belgeler	CB, CE, RoHS, TSE			
Kutup	1-4P			
Anma Akımı In	1, 2, 3, 4, 6, 10, 16, 20, 25, 32, 40, 50, 63A			
Anma Gerilimi Ue	240/415V AC			
İzolasyon Gerilimi Ui	500V			
Elektriksel Özellikler	Kesme Kapasitesi Icn			
	Anma (A)	Kesme Kapasitesi Icn(kA)	Tip	Kutup
	1-63	4,5-6	B, C	1P 2P, 3P, 4P
Mekanik Özellikler	Açma Eğrisi			
	B eğrisi; manyetik açma 3 - 5 In C eğrisi; manyetik açma 5 - 10 In			
Bağlantı	Elektriksel Ömür	7000 aç-kapa		
	Mekanik Ömür	20000 aç-kapa		
	Koruma Sınıfı	IP20		
	Ortam Sıcaklığı	-20°C ~ +60°C		
Kurulum	Maks. 25mm ² iletken			
	Anma (A)	Vida	Maks. Tok (Nm)	
Montaj	1-63	M5	2.5	
	35mm DIN-RAY			
Aksesuarlar	Yardımcı Kontak	OF		
	Hata Bildirim	SD		
	Açtırma Bobini	MX+OF		

Aksesuarlar



SD





OF



MX+OF

Referans Kodu	Açıklama	Birim Fiyat (₺)
HDB3wSD	Hata Bildirim Kontak	175,00
HDB3wOF	Yardımcı Kontak	134,00
HDB3wMO220	Açtırma Bobini	456,00

Kutup Sayısı	Anma Akımı (A)	Referans Kodu	Birim Fiyat (₺)	Kutu (Adet)	Koli (Adet)	
	1 Kutup	6 A	HDB9H63A1C6	133,00	12	144
	1 Kutup	10 A	HDB9H63A1C10	125,00	12	144
	1 Kutup	16 A	HDB9H63A1C16	125,00	12	144
	1 Kutup	20 A	HDB9H63A1C20	125,00	12	144
	1 Kutup	25 A	HDB9H63A1C25	125,00	12	144
	1 Kutup	32 A	HDB9H63A1C32	133,00	12	144
	1 Kutup	40 A	HDB9H63A1C40	140,00	12	144
	1 Kutup	50 A	HDB9H63A1C50	172,00	12	144
	1 Kutup	63 A	HDB9H63A1C63	209,00	12	144
	2 Kutup	6 A	HDB9H63A2C6	310,00	6	72
	2 Kutup	10 A	HDB9H63A2C10	282,00	6	72
	2 Kutup	16 A	HDB9H63A2C16	282,00	6	72
	2 Kutup	20 A	HDB9H63A2C20	282,00	6	72
	2 Kutup	25 A	HDB9H63A2C25	282,00	6	72
	2 Kutup	32 A	HDB9H63A2C32	317,00	6	72
	2 Kutup	40 A	HDB9H63A2C40	349,00	6	72
	2 Kutup	50 A	HDB9H63A2C50	383,00	6	72
	2 Kutup	63 A	HDB9H63A2C63	437,00	6	72
	3 Kutup	6 A	HDB9H63A3C6	383,00	4	48
	3 Kutup	10 A	HDB9H63A3C10	410,00	4	48
	3 Kutup	16 A	HDB9H63A3C16	410,00	4	48
	3 Kutup	20 A	HDB9H63A3C20	410,00	4	48
	3 Kutup	25 A	HDB9H63A3C25	410,00	4	48
	3 Kutup	32 A	HDB9H63A3C32	417,00	4	48
	3 Kutup	40 A	HDB9H63A3C40	427,00	4	48
	3 Kutup	50 A	HDB9H63A3C50	483,00	4	48
	3 Kutup	63 A	HDB9H63A3C63	546,00	4	48
	4 Kutup	6 A	HDB9H63A4C6	530,00	3	36
	4 Kutup	10 A	HDB9H63A4C10	504,00	3	36
	4 Kutup	16 A	HDB9H63A4C16	504,00	3	36
	4 Kutup	20 A	HDB9H63A4C20	504,00	3	36
	4 Kutup	25 A	HDB9H63A4C25	504,00	3	36
	4 Kutup	32 A	HDB9H63A4C32	528,00	3	36
	4 Kutup	40 A	HDB9H63A4C40	570,00	3	36
	4 Kutup	50 A	HDB9H63A4C50	707,00	3	36
	4 Kutup	63 A	HDB9H63A4C63	731,00	3	36
1 Kutup	16A	HDB9H63A1B16	125,00	12	144	
	20A	HDB9H63A1B20	125,00	12	144	
	25A	HDB9H63A1B25	125,00	12	144	
	32A	HDB9H63A1B32	133,00	12	144	
	40A	HDB9H63A1B40	140,00	12	144	
	50A	HDB9H63A1B50	172,00	12	144	
	63A	HDB9H63A1B63	209,00	12	144	
	3 Kutup	16A	HDB9H63A3B16	410,00	4	48
20A		HDB9H63A3B20	410,00	4	48	
25A		HDB9H63A3B25	410,00	4	48	
32A		HDB9H63A3B32	417,00	4	48	
40A		HDB9H63A3B40	427,00	4	48	
50A		HDB9H63A3B50	483,00	4	48	
3 Kutup	63A	HDB9H63A3B63	546,00	4	48	

Teknik Özellikler

Otomatik Sigorta	HDB9s 18mm Devre Kesici				
Elektriksel Özellikler	Standart	IEC 60898-1			
	Belgeler	KEMA, CB,CE, TSE, RoHS			
	Kutup	1-4P			
	Anma Akımı In	1, 2, 3, 4, 5, 6, 8, 10, 13, 16, 20, 25, 32, 40, 50, 63A			
	Anma Gerilimi Ue	230/400V AC			
	İzolasyon Gerilimi Ui	500V			
	Kesme Kapasitesi Icn				
	Anma (A)	Kesme Kapasitesi Icn(kA)	Tip	Kutup	Gerilim (V)
	1-63	6	B,C	1P 2P, 3P, 4P	230/400 400
	1-63	10	B,C	1P 2P, 3P, 4P	230/400 400
Açma Eğrisi					
B eğrisi; manyetik açma 3 - 5 In					
C eğrisi; manyetik açma 5 - 10 In					
Mekanik Özellikler	Elektriksel Ömür	10000 aç-kapa			
	Mekanik Ömür	20000 aç-kapa			
	Koruma Derecesi	IP20			
	Ortam Sıcaklığı	-30°C ~ +70°C			
Bağlantı	1-63A Maks 25mm ² iletken				
Kurulum	Anma (A)	Vida	Maks. Tok (Nm)	Min. Tork (Nm)	
	1-63	M5	2.5	2.0	
Montaj	35mm DIN-RAY				
Aksesuarlar	Yardımcı Kontak	OF			
	Hata Bildirim	SD			
	Açtırma Bobini	MX+OF			

Boyutlar

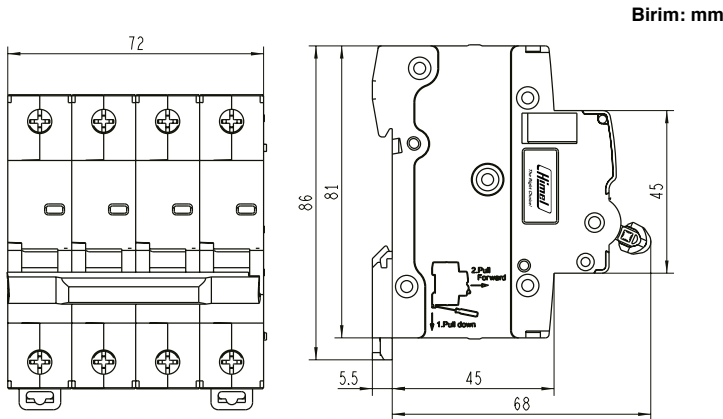





Kutup Sayısı	Anma Akımı (A)	Referans Kodu	Birim Fiyat (TL)	Kutu (Adet)	Koli (Adet)
1 Kutup	63	HDB3w125H1C63	209,00	12	108
1 Kutup	80	HDB3w125H1C80	345,00	12	108
1 Kutup	100	HDB3w125H1C100	354,00	12	108
1 Kutup	125	HDB3w125H1C125	394,00	12	108
2 Kutup	63	HDB3w125H2C63	437,00	6	54
2 Kutup	80	HDB3w125H2C80	705,00	6	54
2 Kutup	100	HDB3w125H2C100	931,00	6	54
2 Kutup	125	HDB3w125H2C125	1.211,00	6	54
3 Kutup	63	HDB3w125H3C63	546,00	4	36
3 Kutup	80	HDB3w125H3C80	1.128,00	4	36
3 Kutup	100	HDB3w125H3C100	1.186,00	4	36
3 Kutup	125	HDB3w125H3C125	1.353,00	4	36
4 Kutup	63	HDB3w125H4C63	731,00	3	27
4 Kutup	80	HDB3w125H4C80	1.265,00	3	27
4 Kutup	100	HDB3w125H4C100	1.598,00	3	27
4 Kutup	125	HDB3w125H4C125	1.951,00	3	27

Teknik Özellikler

Elektriksel Özellikler

Anma izolasyon gerilimi U_i	(V)	250 (fazdan nötre) / 500 (fazdan faza)
Max. çalışma yükü U_{Bmax}	1P+N (V)	230/400 AC
	2P,3P,4P	
Anma kısa devre kapasitesi I_{cn} (IEC/EN60898)	(KA)	6, 10
Anma darbe dayanım gerilimi (1.2/50)	(KA)	4
Dielektrik test gerilimi		2kV (50/60Hz60 1 dk.)
İzolasyon özelliği		Var
Kirlilik sınıfı		2
Koruma		Termik manyetik koruma
Termik manyetik koruma karakteristiği	C eğrisi ($I_i=8.5I_n$)	
	D eğrisi ($I_i=12I_n$)	
Elektriksel ve Mekanik Özellikler		

Mekanik Özellikler

Mekanik ömür	Aç - Kapa	8500 kez ($I_n \leq 100A$) 7000 kez ($I_n > 100A$)
Elektriksel ömür	Aç - Kapa	3000 kez ($I_n \leq 100A$) 2500 kez ($I_n > 100A$)
Ortam sıcaklığı	°C	30°C
Çalışma ortam sıcaklığı (günlük ortalama sıcaklık $\leq +35^\circ C$)	°C	-20°C ~+60°C
Saklama sıcaklığı	°C	-40°C ~+70°C



Kutup/Hassasiyet	Anma Akımı (A)	Referans Kodu	Birim Fiyat (₺)	Kutu (Adet)	Koli (Adet)
2 Kutup 30 mA	25 A	HDB3VR225SC	491,00	1	60
2 Kutup 30 mA	32 A	HDB3VR232SC	491,00	1	60
2 Kutup 30 mA	40 A	HDB3VR240SC	491,00	1	60
2 Kutup 30 mA	63 A	HDB3VR263SC	557,00	1	60
2 Kutup 300 mA	25 A	HDB3VR225TC	491,00	1	60
2 Kutup 300 mA	32 A	HDB3VR232TC	491,00	1	60
2 Kutup 300 mA	40 A	HDB3VR240TC	491,00	1	60
2 Kutup 300 mA	63 A	HDB3VR263TC	557,00	1	60
2 Kutup 300 mA	80 A	HDB3VR280TC	793,00	1	60
2 Kutup 300 mA	100 A	HDB3VR2100TC	857,00	1	60
4 Kutup 30 mA	25 A	HDB3VR425SC	699,00	1	30
4 Kutup 30 mA	32 A	HDB3VR432SC	699,00	1	30
4 Kutup 30 mA	40 A	HDB3VR440SC	699,00	1	30
4 Kutup 30 mA	63 A	HDB3VR463SC	814,00	1	30
4 Kutup 30 mA	80 A	HDB3VR480SC	1.165,00	1	30
4 Kutup 30 mA	100 A	HDB3VR4100SC	1.262,00	1	30
4 Kutup 300 mA	25 A	HDB3VR425TC	699,00	1	30
4 Kutup 300 mA	32 A	HDB3VR432TC	699,00	1	30
4 Kutup 300 mA	40 A	HDB3VR440TC	699,00	1	30
4 Kutup 300 mA	63 A	HDB3VR463TC	814,00	1	30
4 Kutup 300 mA	80 A	HDB3VR480TC	1.165,00	1	30
4 Kutup 300 mA	100 A	HDB3VR4100TC	1.262,00	1	30

Teknik Özellikler

Boyutlar

Birim: mm

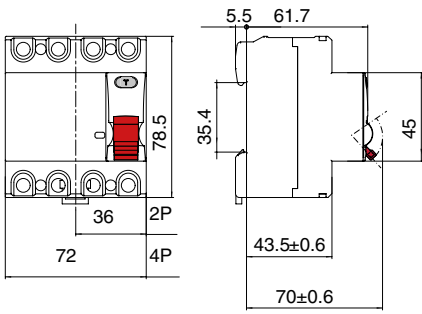

HDB3VR-63

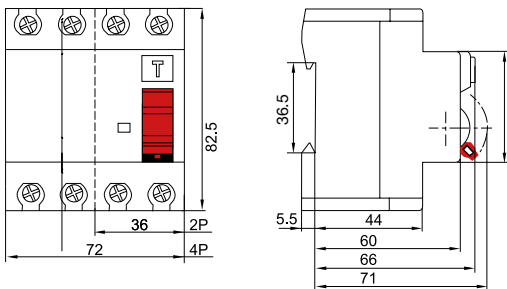

HDB3VR-100

HDB3VR Kaçak Akım Koruma Anahtarı				
Elektriksel Özellikler	Standart	IEC61008-1		
	Belgeler	TUV,CE, CB, TSE		
	Tip	AC, A, Elektromagnetik tip		
	Kutup	2, 4		
	Anma Akımı In	10,16,25,32,40,63,80,100 A		
	Anma Gerilimi Ue	230/400V AC		
	İzolasyon Gerilimi Ui	500V		
	Hassasiyet	10, 30, 100, 300mA		
	Mekaniksel Özellikler	Elektriksel Ömür	1000 aç-kapa	
		Mekanik Ömür	2000 aç-kapa	
Aşırı Akım veya Kısa Devre Koruma		Yok		
Açma Bildirimi		Ani Anma Kaçak İşletme Akımı, Ayarsız		
Hata Bildirimi		Mekaniksel, Ön tarafta		
Koruma Derecesi		IP20		
Ortam Sıcaklığı		-25°C ~ +40°C		
Bağlantı	Maks. 25mm ² iletken (In≤63A)	Maks. 25mm ² iletken (In>63A)		
Kurulum	Anma (A)	Vida	Maks. Tork (Nm)	Min. Tork (Nm)
	25-100M	5	3.0	2.0
Montaj	35mm DIN-RAY			

HDM3 Serisi Sabit Tip Kompakt Şalterler (3 Kutuplu)



Icu (kA)	In (A)	Referans Kodu	Birim Fiyat (₺)	Kutu (Adet)	Koli (Adet)
50 kA	25A	HDM363F2533XX	1.257,00	1	24
50 kA	32A	HDM363F3233XX	1.257,00	1	24
50 kA	40A	HDM363F4033XX	1.257,00	1	24
50 kA	50A	HDM363F5033XX	1.257,00	1	24
50 kA	63A	HDM363F6333XX	1.257,00	1	24
50 kA	80A	HDM3100N8033XX	1.443,00	1	16
50 kA	100A	HDM3100N10033XX	1.443,00	1	16
60 kA	125A	HDM3160N12533XX	1.620,00	1	12
60 kA	160A	HDM3160N16033XX	1.841,00	1	12
60 kA	200A	HDM3250N20033XX	2.258,00	1	12
60 kA	250A	HDM3250N25033XX	2.538,00	1	12
70 kA	315A	HDM3400N31533XX	5.320,00	1	4
70 kA	400A	HDM3400N40033XX	5.569,00	1	4
70 kA	500A	HDM3630N50033XX	7.555,00	1	4
70 kA	630A	HDM3630N63033XX	7.995,00	1	4
70 kA	800A	HDM3800F80033XX	13.535,00	1	2
70 kA	1000A	HDM31600N100033XX	25.568,00	1	1
70 kA	1250A	HDM31600N125033XX	29.393,00	1	1

HDM3 Serisi Sabit Tip Kompakt Şalterler (4 Kutuplu)



Icu (kA)	In (A)	Referans Kodu	Birim Fiyat (₺)	Kutu (Adet)	Koli (Adet)
50 kA	40A	HDM363F40B3XX	2.118,00	1	18
50 kA	50A	HDM363F50B3XX	2.118,00	1	18
50 kA	63A	HDM363F63B3XX	2.118,00	1	18
50 kA	80A	HDM3100N80B3XX	2.383,00	1	12
50 kA	100A	HDM3100N100B3XX	2.383,00	1	12
60 kA	125A	HDM3160N125B3XX	2.914,00	1	8
60 kA	160A	HDM3160N160B3XX	3.336,00	1	8
60 kA	200A	HDM3250N200B3XX	4.191,00	1	8
60 kA	250A	HDM3250N250B3XX	4.262,00	1	8
70 kA	315A	HDM3400N315B3XX	8.051,00	1	2
70 kA	400A	HDM3400N400B3XX	8.487,00	1	2
70 kA	500A	HDM3630N500B3XX	10.359,00	1	2
70 kA	630A	HDM3630N630B3XX	12.013,00	1	2
70 kA	800A	HDM3800F800B3XX	16.226,00	1	1

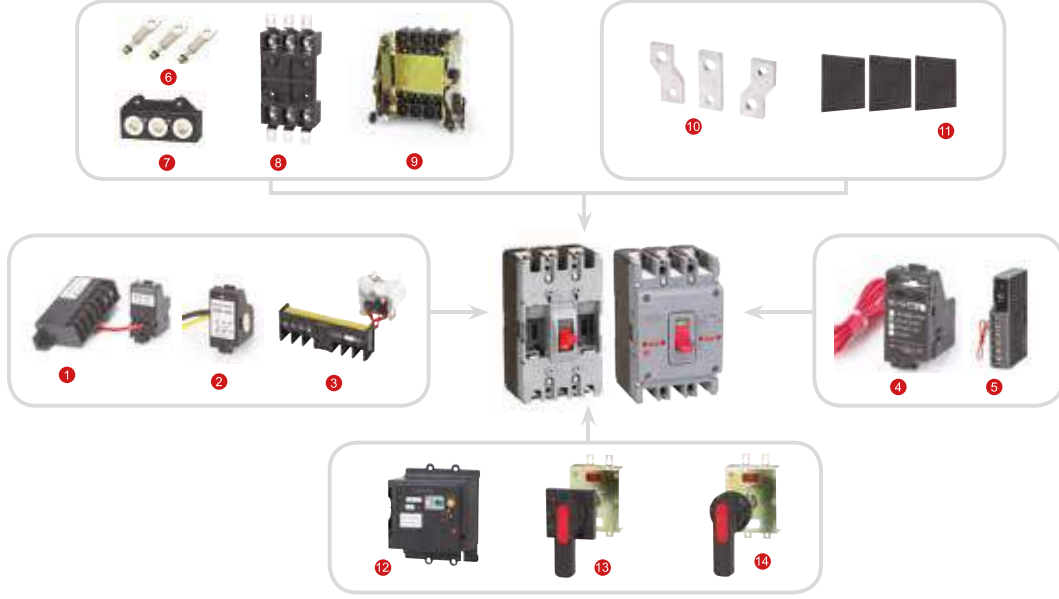

1	Düşük Gerilim Bobini	6	Sabit, Arka Bağlantı Aparatı	11	Seperatör
2	Yardımcı Kontak	7	Fiş Tipi Arka Bağlantı Aparatı	12	Motor Mekanizması
3	Alarm Kontakı	8	Fiş Tipi Ön Bağlantı Aparatı	13	Kare Uzatma Kolu
4	Açtırma Bobini	9	Sürgülü Bağlantı Aparatı	14	Dairesel Uzatma Kolu
5	Kaçak Alarm Modülü	10	Bağlantı Barası		

Referans Kodu	Açıklama	Birim Fiyat (₺)	Kutu (Adet)	Koli (Adet)
HDM363OF11K1BL	63 Yardımcı Kontak (Sol) (1NO 1NC)	234,00	20	480
HDM3100FNOF11K1BL	100 Yardımcı Kontak (Sol) (1NO 1NC)	267,00	20	480
HDM3160OF11K1BL	160 Yardımcı Kontak (Sol) (1NO 1NC)	304,00	20	480
HDM3250OF11K1BL	250 Yardımcı Kontak (Sol) (1NO 1NC)	353,00	20	480
HDM3400OF11K1BL	400 Yardımcı Kontak (Sol) (1NO 1NC)	392,00	8	192
HDM3630OF11K1BL	630 Yardımcı Kontak (Sol) (1NO 1NC)	429,00	8	192
HDM31600OF12K2BR	1250 Yardımcı Kontak (Sağ) (1NO 1NC)	497,00	1	1
HDM3250HL1	250 Dairesel Uzatma Kolu	720,00	1	16
HDM3400HL1	400 Dairesel Uzatma Kolu	730,00	2	4
HDM3630HL1	630 Dairesel Uzatma Kolu	749,00	2	4
HDM3800HL1	800 Dairesel Uzatma Kolu	825,00	2	4
HDM31600HL2	1250 Dairesel Uzatma Kolu	3.492,00	1	1
HDM363MX1A2	63 Açtırma Bobini (Sol) AC230V	478,00	20	480
HDM3100FNMX1A2	100 Açtırma Bobini (Sol) AC230V	490,00	20	480
HDM3160MX1A2	160 Açtırma Bobini (Sol) AC230V	503,00	20	480
HDM3250MX1A2	250 Açtırma Bobini (Sol) AC230V	618,00	8	192
HDM3400MX1A2	400 Açtırma Bobini (Sol) AC230V	1.077,00	8	192
HDM3630MX1A2	630 Açtırma Bobini (Sol) AC230V	1.165,00	8	192
HDM3800MX1A2R	800 Açtırma Bobini (Sol) AC230V	1.280,00	1	1
HDM31600MX1A2L	1250 Açtırma Bobini (Sol) AC230V	991,00	1	1
HDM363D1A2	25A - 63A Motor Mekanizması AC230V	5.581,00	1	16
HDM3100FND1A2	80A-100A Motor Mekanizması AC230V	5.581,00	1	16
HDM3160FD1A2	125A-160A Motor Mekanizması AC230V	5.945,00	1	16
HDM3250FD1A2	200A-250A Motor Mekanizması AC230V	5.945,00	1	16
HDM3400D1A2	315A-400A Motor Mekanizması AC230V	9.377,00	2	4
HDM3630D1A2	500A-630A Motor Mekanizması AC230V	9.377,00	2	4
HDM3800D1A2	800A Motor Mekanizması AC230V	10.045,00	2	4
HDM31600CD1A2	1000A-1250A Motor Mekanizması AC230V	17.937,00	1	1

Boyutlar

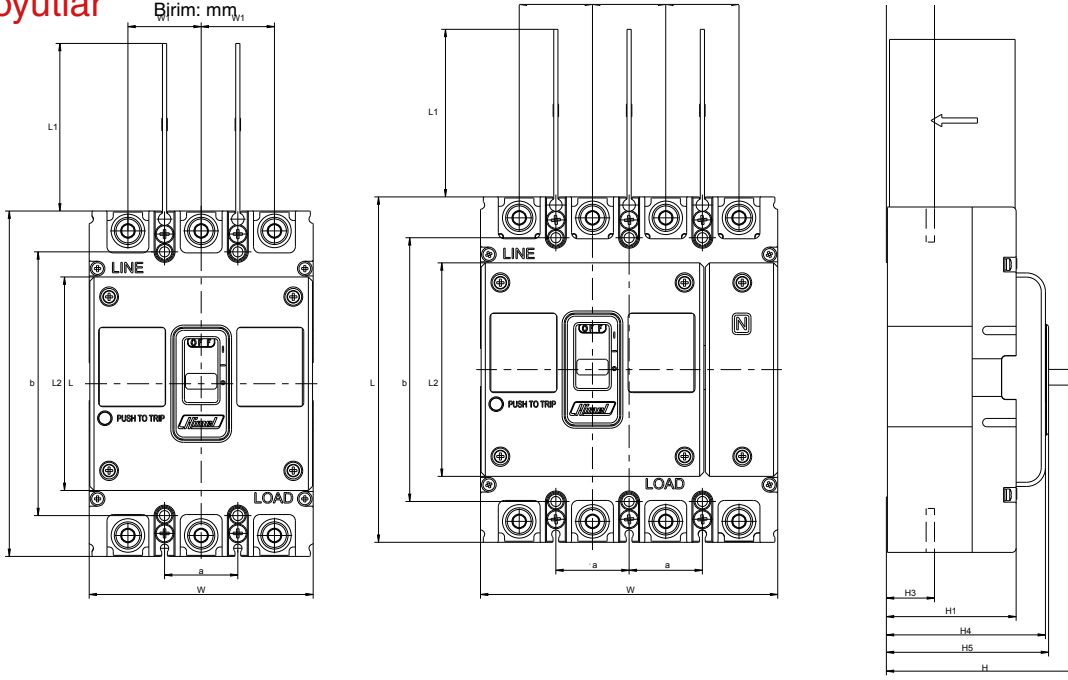

Kasa Tipi	Kutup Sayısı	Kasa Ölçüleri											Montaj Ölçüleri	
		L	L1	L2	W	W1	H	H1	H2	H3	H4	H5	a	b
63	3P	130	50	83	75	25	81.5	54	24	24	68	70.5	25	111
	4P				100									
100	3P	150	50	96	92	30	111.5	81	28.5	28	93.5	95.5	30	129
	4P				122									
160/250	3P	165	80	102	107	35	112.5	80	23	23	94	95.5	35	126
	4P				142									
400	3P	257	104.5	150	150	48	145.9	96.2	36	36.5	107.5	112.5	44	215
	4P				198									
630	3P	257	104.5	150	150	48	145.9	96.2	38	39	107.5	112.5	44	215
	4P				198									
800	3P	280	104.5	102	210	70	146.5	97.5	32.5	35.5	100	114	70	243
	4P				280									
1250	3P	406	104	97.2	210	70	197.5	134	58	60	140	158.5	70	376

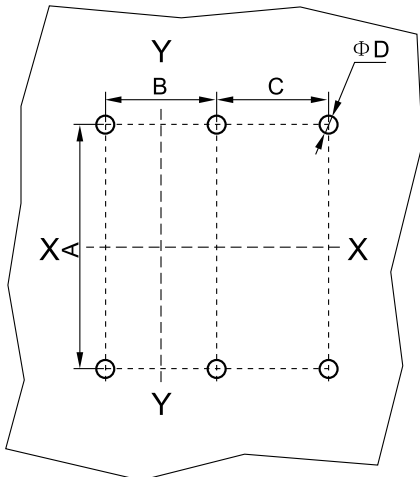

Kasa Tipi	Kutup Sayısı	A	B	C	D
63	3P	111	25	/	4.5
	4P			25	
100	3P	129	30	/	5
	4P			30	
160/250	3P	126	35	/	5.5
	4P			35	
400/630	3P	215	44	/	6.5
	4P			/	
800	3P	243	70	/	7.5
	4P			70	
1250	3P	376	70	/	10.5

HDM3s Serisi Kompakt Şalterler



Reliable made affordable.

HDM3S Serisi Termik Ayarlı Kompakt Şalterler (3 Kutup)



Icu (kA)	In (A)	Manyetik Ayar Sahası (A)	Referans Kodu	Birim Fiyat (₺)	Kutu (Adet)	Koli (Adet)
35kA	20-25A	-	HDM3S160M02531XX	1.966,00	1	16
35kA	32-40A	-	HDM3S160M04031XX	1.966,00	1	16
35kA	50-63A	315-630A	HDM3S160M06333XX	1.966,00	1	16
35kA	64-80A	400-800A	HDM3S160M08033XX	1.843,00	1	16
35kA	80-100A	500-1000A	HDM3S160M10033XX	1.843,00	1	16
35kA	100-125A	625-1250A	HDM3S160M12533XX	2.324,00	1	16
35kA	125-160A	800-1600A	HDM3S160M16033XX	2.400,00	1	16
35kA	160-200A	1000-2000A	HDM3S250M20033XX	2.933,00	1	12
35kA	200-250A	1250-2500A	HDM3S250M25033XX	3.207,00	1	12
50kA	315-400A	2000-4000A	HDM3S400M40033XX	6.804,00	1	2
50kA	400-500A	2500-5000A	HDM3S630M50033XX	9.812,00	1	2
50kA	500-630A	3150-6300A	HDM3S630M63033XX	11.501,00	1	2
50kA	*350-800A	-	HDM3E800M80033XX	15.527,00	1	1
50kA	*630-1600A	-	HDM3E16M163F555L	46.876,00	1	1
50kA	**630-1600A	-	HDM3E16M163NNNL	66.158,00	1	1

Not: * Elektronik açtırma ünitesidir.

** Elektronik açtırma ünitesidir. AC230V Motor Mekanizması, Açtırma Bobini, Düşük Gerilim Bobini standart olarak bulunur.

HDM3S Serisi Termik Ayarlı Kompakt Şalterler (4 Kutup)



Icu (kA)	In (A)	Manyetik Ayar Sahası (A)	Referans Kodu	Birim Fiyat (₺)	Kutu (Adet)	Koli (Adet)
35kA	32-40A	-	HDM3S160M040B1XX	2.637,00	1	12
35kA	50-63A	315-630A	HDM3S160M063B3XX	2.637,00	1	12
35kA	64-80A	400-800A	HDM3S160M080B3XX	2.743,00	1	12
35kA	80-100A	500-1000A	HDM3S160M100B3XX	2.743,00	1	12
35kA	100-125A	625-1250A	HDM3S160M125B3XX	4.111,00	1	12
35kA	125-160A	800-1600A	HDM3S160M160B3XX	4.443,00	1	12
35kA	160-200A	1000-2000A	HDM3S250M200B3XX	4.884,00	1	8
35kA	200-250A	1250-2500A	HDM3S250M250B3XX	5.173,00	1	8
50kA	315-400A	2000-4000A	HDM3S400M400B3XX	12.157,00	1	2
50kA	400-500A	2500-5000A	HDM3S630M500B3XX	15.082,00	1	2
50kA	500-630A	3150-6300A	HDM3S630M630B3XX	17.337,00	1	2
50kA	*350-800A	-	HDM3E800M800C3XX	17.585,00	1	1
50kA	*630-1600A	-	HDM3E16M164F555L	59.666,00	1	1
50kA	**630-1600A	-	HDM3E16M164FNNNL	73.462,00	1	1

Not: * Elektronik açtırma ünitesidir.

** Elektronik açtırma ünitesidir. AC230V Motor Mekanizması, Açtırma Bobini, Düşük Gerilim Bobini standart olarak bulunur.

Kasa Tipi (A)	Anma Akımı (A) @ 40° In																
	25	32	40	50	63	80	100	125	140	160	200	250	320	400	500	630	
160	■																
250									■								
400												■					
630														■			

Teknik Özellikler

Kasa Tipi	HDM3S-160		HDM3S-250		HDM3S-400		HDM3S-630	
Standart	IEC 60947-2		IEC 60947-2		IEC 60947-2		IEC 60947-2	
[Uimp] Anma Darbe Dayanım Gerilimi	8kV		8kV		8kV		8kV	
[Ui] Anma İzolasyon Gerilimi	AC1000V		AC1000V		AC1000V		AC1000V	
Frekans	50/60 Hz		50/60 Hz		50/60 Hz		50/60 Hz	
[Ue] Anma Gerilimi	400/415VAC		400/415VAC		400/415VAC		400/415VAC	
Kutup	3/4		3/4		3/4		3/4	
Yalıtıma Uygunluk	Evet		Evet		Evet		Evet	
Kullanım Kategorisi	Kategori A		Kategori A		Kategori A		Kategori A	
[In] Nominal Akım	25/32/40/50	63/80/100/125/160	140/160/200/250	250/320/400	500/630			
Termik Ayar	0.8,0.9,1.0	0.8,0.9,1.0	0.8,0.9,1.0	0.8,0.9,1.0	0.8,0.9,1.0			
Manyetik Ayar	/	5,6,7,8,9,10	5,6,7,8,9,10	5,6,7,8,9,10	5,6,7,8,9,10			
Kesme Kapasitesi	M		M		M		M	
400VAC Icu	35		35		50		50	
400VAC Ics	35		35		50		50	
Mekanik Ömür	8500		7000		4000		4000	
Elektriksel Ömür	1500		1000		1000		1000	
Boyut (En x Boy x Derinlik)	90-155-108(3P)/ 120-155-108(4P)		105-165-116(3P)/ 140-165-116(4P)		140-257-155(3P)/ 184-257-155(4P)		140-257-155(3P)/ 184-257-155(4P)	
Ortam Sıcaklığı	40/50 °C		40/50 °C		40/50 °C		40/50 °C	
Sertifikalar	TUV/ CB / TSE		TUV/ CB / TSE		TUV/ CB / TSE		TUV/ CB / TSE	

HDM3S Montaj Ölçüleri (mm)

Montaj için Ön Bağlantı Ölçüleri

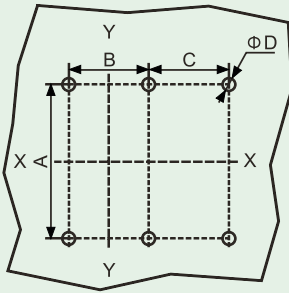

Not: x-x, y-y ile işaretlenmiş noktalar 3 kutuplu devre kesicinin merkezini belirtir.

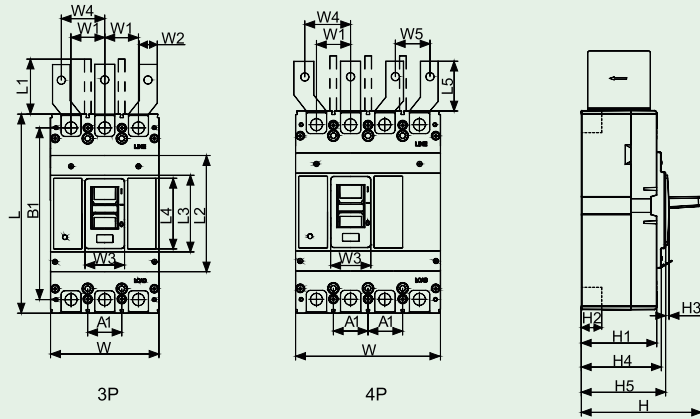

HDM3S Serisi Kompakt Şalterler

Himel

Reliable made affordable.

Model	Kutup				
		A	B	C	D
HDM3S-160	3	132	30	/	4.5
	4	132	30	30	4.5
HDM3S-250	3	126	35	/	4.5
	4	126	35	35	4.5
HDM3S-400/630	3	194	44	/	7
	4	194	44	44	7

Model	Kutup																				
		L	L1	L2	L3	L4	L5	W	W1	W2	W3	W4	W5	H	H1	H2	H3	H4	H5	A1	B1
HDM3S-160	3P	155	98	121	55	50	21.8	90	30	15	25.3	39	/	107	75	20	2.6	82	87	30	134
	4P	155	98	121	55	50	21.8	120	30	15	25.3	39	30	107	75	20	2.6	82	87	30	134
HDM3S-250	3P	165	98	102	59	50	41.8	105	35	20	24	42	/	116	81	23	3	88	93	35	144
	4P	165	98	102	59	50	41.8	140	35	20	24	42	35	116	81	23	3	88	93	35	144
HDM3S-400/630	3P	257	98	150	99	91	45.4	140	43.5	28	51	56	/	150	97	30	4	103	109	44	230
	4P	257	98	150	99	91	45.4	185	43.5	28	51	56	44	150	97	30	4	103	109	44	230

Montaj İçin Arka Bağlantı Ölçüleri

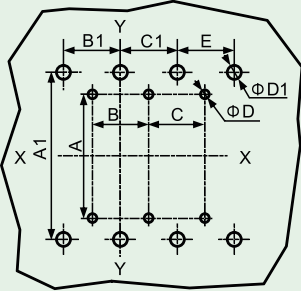

Not: x-x, y-y ile işaretlenmiş noktalar 3 kutuplu devre kesicinin merkezini belirtir.

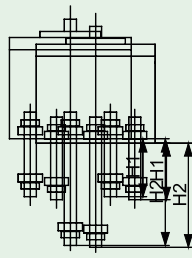

160/250 3P

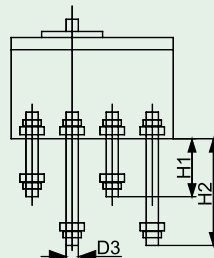

160/250 4P

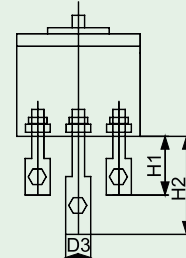

400/630 3P

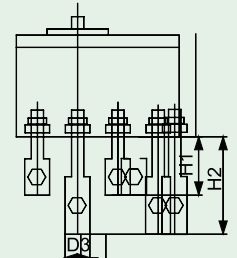

400/630 4P

Model	Kutup												
		A	B	C	D	A1	B1	C1	E	D1	H1	H2	D3
HDM3S-160	3	132	30	/	4.5	134	30	30	/	9.8	112	72	8
	4	132	30	30	4.5	134	30	30	30	9.8	112	72	8
HDM3S-250	3	126	35	/	4.5	144	35	35	/	8	126	87	8
	4	126	35	35	4.5	144	35	35	35	8	126	87	8
HDM3S-400	3	194	44	/	7	230	43.5	43.5	/	10.5	136	83	30
	4	194	44	44	7	230	43.5	43.5	44	10.5	136	83	30
HDM3S-630	3	194	44	/	7	230	43.5	43.5	/	10.5	136	83	32
	4	194	44	44	7	230	43.5	43.5	44	10.5	136	83	32



Referans Kodu	Açıklama	Birim Fiyat (₺)	Kutu (Adet)	Koli (Adet)
HDM3S160OF11L	HDM3s-160 Yardımcı kontak (Sol) (1NO 1NC)	225,00	1	320
HDM3S250OF11L	HDM3s-250 Yardımcı kontak (Sol) (1NO 1NC)	263,00	1	320
HDM3S630OF11L	HDM3s-400/630 Yardımcı kontak (Sol) (1NO 1NC)	321,00	1	64



HDM3S160MOA2	HDM3s-160 AC Motor Mekanizması AC230V	5.063,00	1	8
HDM3S250MOA2	HDM3s-250 AC Motor Mekanizması AC230V	4.816,00	1	12
HDM3S630MOA2	HDM3s-400/630 AC Motor Mekanizması AC230V	7.398,00	1	2
HDM3E800D2	HDM3E-800 Motor Mekanizması AC230V	11.893,00	1	1



HDM3S160H2	HDM3s-160 Kare Uzatma Kolu	596,00	1	16
HDM3S250H2	HDM3s-250 Kare Uzatma Kolu	651,00	1	16
HDM3S630H2	HDM3s-400/630 Kare Uzatma Kolu	767,00	1	8



HDM3S160MN2A2R	HDM3s-160 Düşük Gerilim Bobini (Sağ) AC230V	929,00	1	160
HDM3S250MN2A2R	HDM3s-250 Düşük Gerilim Bobini (Sağ) AC230V	1.077,00	1	160
HDM3S630MN2A2R	HDM3s-400/630 Düşük Gerilim Bobini (Sağ) AC230V	1.459,00	1	48
HDM3E800MNA2L	HDM3E-800 Düşük Gerilim Bobini (Sol) AC230V	1.331,00	4	24



HDM3S160MX1A2R	HDM3s-160 Açtırma Bobini (Sağ) AC230V	373,00	1	320
HDM3S250MX1A2R	HDM3s-250 Açtırma Bobini (Sağ) AC230V	410,00	1	320
HDM3S630MX1A2R	HDM3s-400/630 Açtırma Bobini (Sağ) AC230V	997,00	1	64
HDM3E800MX1A2	HDM3E-800 Açtırma Bobini (Sağ) AC230V	991,00	4	16

HDM3S Serisi Kompakt Şalter Aksesuarları

Himel

Reliable made affordable.

HDM3S Aksesuarlar ve Yardımcı Donanımlar

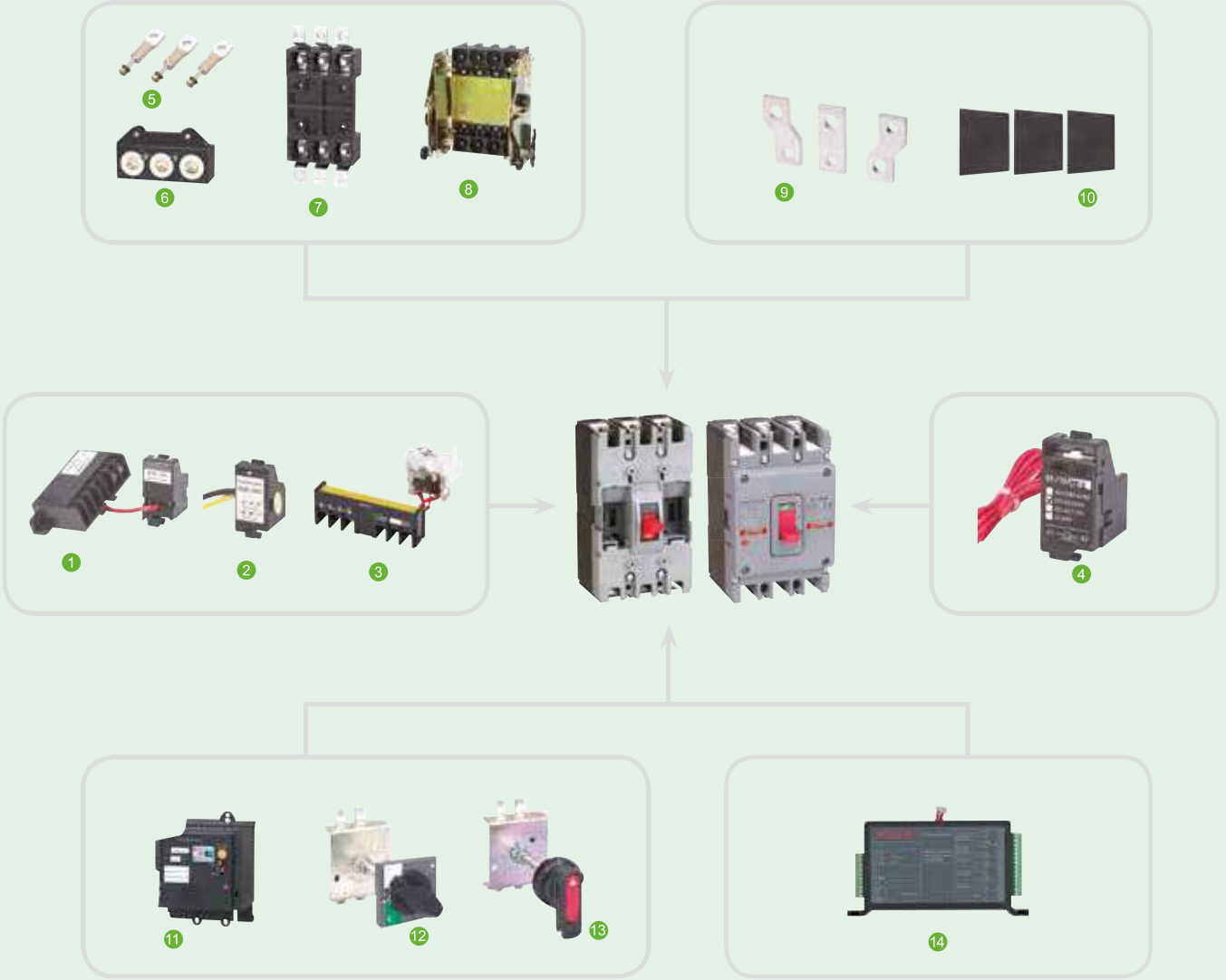

1	Düşük Gerilim Bobini	7	Fiş Tipi Ön Bağlantı Aparatı	13	Dairesel Uzatma Kolu
2	Yardımcı Kontak	8	Sürgülü Bağlantı Aparatı	14	EI Klidi
3	Alarm Kontakı	9	Bağlantı Barası		
4	Açtırma Bobini	10	Seperatör		
5	Sabit Tip Arka Bağlantı Aparatı	11	AC Motor Mekanizması		
6	Fiş Tipi Arka Bağlantı Aparatı	12	Kare Uzatma Kolu		

HDM6S Serisi Termik Ayarlı Kompakt Şalterler (3 Kutup)



Icu (kA)	In (A)	Referans Kodu	Birim Fiyat (₺)	Kutu (Adet)	Koli (Adet)
50kA	12,5-16A	HDM6S100M0163XXX3	1.966,00	1	10
50kA	20-25A	HDM6S100M0253XXX3	1.966,00	1	10
50kA	32-40A	HDM6S100M0403XXX3	1.966,00	1	10
50kA	50-63A	HDM6S100M0633XXX3	1.966,00	1	10
50kA	80-100A	HDM6S100M1003XXX3	1.843,00	1	10
50kA	100-125A	HDM6S250M1253XXX3	2.324,00	1	8
50kA	125-160A	HDM6S250M1603XXX3	2.400,00	1	8
50kA	160-200A	HDM6S250M2003XXX3	2.933,00	1	8
50kA	200-250A	HDM6S250M2503XXX3	3.207,00	1	8
70kA	315-400A	HDM6S400M4003XXX3	6.804,00	1	4
70kA	400-500A	HDM6S630M5003XXX3	9.812,00	1	2
70kA	500-630A	HDM6S630M6303XXX3	11.501,00	1	2
50kA	*350-800A	HDM3E800M80033XX	15.527,00	1	1
50kA	*630-1600A	HDM3E16M163F555L	46.876,00	1	1
50kA	**630-1600A	HDM3E16M163FNNNL	66.158,00	1	1

Not: * Elektronik açtırma ünitesidir.

** Elektronik açtırma ünitesidir. AC230V Motor Mekanizması, Açtırma Bobini, Düşük Gerilim Bobini standart olarak bulunur.

HDM6S Serisi Termik Ayarlı Kompakt Şalterler (4 Kutup)



Icu (kA)	In (A)	Referans Kodu	Birim Fiyat (₺)	Kutu (Adet)	Koli (Adet)
50kA	32-40A	HDM6S100M0404XXX3	2.637,00	1	8
50kA	50-63A	HDM6S100M0634XXX3	2.637,00	1	8
50kA	80-100A	HDM6S100M1004XXX3	2.743,00	1	8
50kA	100-125A	HDM6S250M1254XXX3	4.111,00	1	8
50kA	125-160A	HDM6S250M1604XXX3	4.443,00	1	8
50kA	160-200A	HDM6S250M2004XXX3	4.884,00	1	8
50kA	200-250A	HDM6S250M2504XXX3	5.173,00	1	8
70kA	315-400A	HDM6S400M4004XXX3	12.157,00	1	2
70kA	400-500A	HDM6S630M5004XXX3	15.082,00	1	2
70kA	500-630A	HDM6S630M6304XXX3	17.337,00	1	2
50kA	*350-800A	HDM3E800M800C3XX	17.585,00	1	1
50kA	*630-1600A	HDM3E16M164F555L	59.666,00	1	1
50kA	**630-1600A	HDM3E16M164FNNNL	73.462,00	1	1

Not: * Elektronik açtırma ünitesidir.

** Elektronik açtırma ünitesidir. AC230V Motor Mekanizması, Açtırma Bobini, Düşük Gerilim Bobini standart olarak bulunur.

Teknik Özellikler

Termik Ayarlı

Temel Teknik Özellikler (IEC60947-2)

Kasa Tipi	100				250				400				630				
	3P		4P		3P		4P		3P		4P		3P		4P		
Kutup Sayısı	M	T	M	T	M	T	M	T	M	T	M	T	M	T	M	T	
Kesme Kapasitesi	M	T	M	T	M	T	M	T	M	T	M	T	M	T	M	T	
Anma Kesme Kapasitesi Icu (kA rms)	50	30	50	30	50	30	50	30	70	40	70	40	70	40	70	40	
Anma İşletim Kesme Kapasitesi Ics (kA rms)	50%	100%	50%	100%	50%	100%	50%	100%	50%	100%	50%	100%	50%	100%	50%	100%	
Mekanik Ömür	8500				7000				4000				4000				
Elektriksel Ömür	1500				1000				1000				1000				
Açma Ünitesi																	
Anma (A)	In	16/25/40/63/100				125/160/200/250				400				500/630			
Termik Ayar Sahası (Ir)	In	0.8/0.9/1.0In				0.8/0.9/1.0In				0.8/0.9/1.0In				0.8/0.9/1.0In			

Aksesuarlar

Aksesuar Seçenekleri

OF																	
SD																	
Kontrol Aksesuarları																	
MX(AC400, 230V, DC220V)																	
MN (AC400, 230V)																	
Uzatma Kolu (Silindir ve Kare)																	
AC Motor Mekanizması (AC400, 230V)																	
Mekanik Kilitleme																	
Montaj & Bağlantı																	
Sabit, Ön Bağlantı																	
Sabit, Arka Bağlantı																	
Geçmeli, Arka Bağlantı																	
Geçmeli, Ön Bağlantı																	
Sürgülü, Arka Bağlantı																	
Bağlantı																	
Yardımcı Bağlantı Aparatı																	
Koruma																	
Seperatör																	

" " Mevcut Opsiyonlar

"- " Mevcut Olmayan Opsiyonlar

HDM6s Aksesuarlar ve Yardımcı Donanımlar

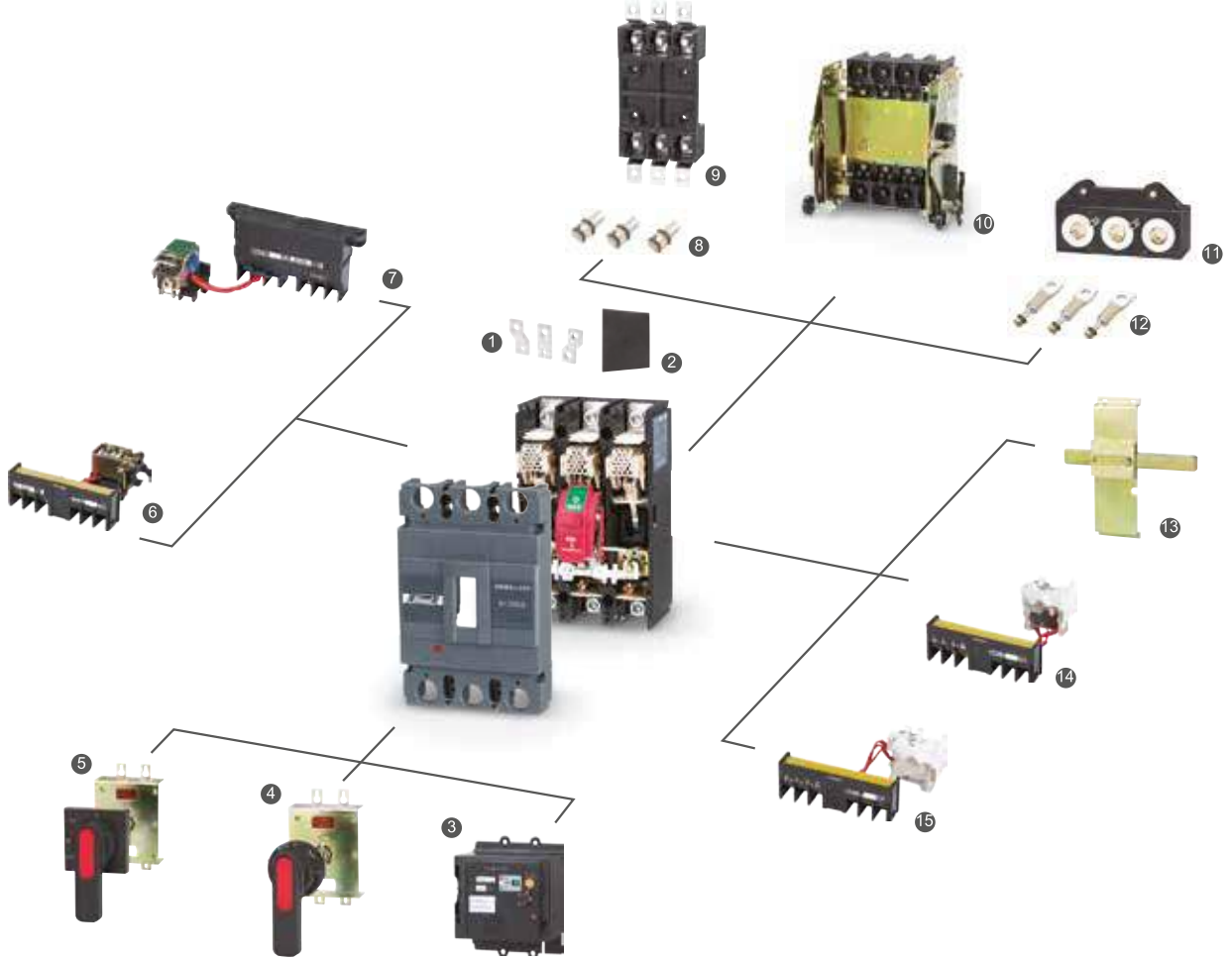

1	Bağlantı Barası	6	MX Bobini	11	Fiş Tipi Arka Bağlantı Aparatı
2	Seperatör	7	MN Bobini	12	Sabit Tip Arka Bağlantı Aparatı
3	AC Motor Mekanizması	8	Fiş Tipi Bağlantı Terminali	13	Mekanik Kilit
4	Uzatmalı Kurma Kolu (Yuvarlak)	9	Fiş Tipi Ön Bağlantı Aparatı	14	SD Kontak
5	Uzatmalı Kurma Kolu (Kare)	10	Sürgülü Bağlantı Aparatı	15	OF Kontak

Referans Kodu	Açıklama	Birim Fiyat (₺)	Kutu (Adet)	Koli (Adet)
HDM6s100MXN3	16A~100A Açırma Bobini (Sağ) AC230V 3P	550,00	16	96
HDM6s250MXN3	125A~250A Açırma Bobini (Sağ) AC230V 3P	642,00	16	96
HDM6s400MXN3	315A~400A Açırma Bobini (Sağ) AC230V 3P	1.122,00	8	48
HDM6s630MXN3	500A~630A Açırma Bobini (Sağ) AC230V 3P	1.220,00	6	36
HDM3E800MX1A2	HDM3E-800 Açırma Bobini (Sağ) AC230V 3P	991,00	4	16
HDM6s100MXN	16A~100A Açırma Bobini (Sol) AC230V 4P	550,00	16	96
HDM6s250MXN	125A~250A Açırma Bobini (Sol) AC230V 4P	642,00	16	96
HDM6s400MXN	315A~400A Açırma Bobini (Sol) AC230V 4P	1.122,00	8	48
HDM6s630MXN	500A~630A Açırma Bobini (Sol) AC230V 4P	1.220,00	6	36
HDM3E800MX1A2	HDM3E-800 Açırma Bobini (Sağ) AC230V 4P	991,00	4	16



HDM6s Serisi Kompakt Şalter Aksesuarları



Reliable made affordable.

Referans Kodu	Açıklama	Birim Fiyat (₺)	Kutu (Adet)	Koli (Adet)
HDM6s100OFL	16A~100A Yardımcı Kontak (Sol) (1NO 1NC)	304,00	10	60
HDM6s250OFL	125A~250A Yardımcı Kontak (Sol) (1NO 1NC)	285,00	10	60
HDM6s400OFL	315A~400A Yardımcı Kontak (Sol) (1NO 1NC)	298,00	8	48
HDM6s630OFL	500A~630A Yardımcı Kontak (Sol) (1NO 1NC)	519,00	8	48
HDM6s100OFL2	16A~100A Yardımcı Kontak (Sol) (2NO 2NC)	396,00	10	60
HDM6s250OFL2	125A~250A Yardımcı Kontak (Sol) (2NO 2NC)	445,00	10	60
HDM6s400OFL2	315A~400A Yardımcı Kontak (Sol) (2NO 2NC)	445,00	8	48
HDM6s630OFL2	500A~630A Yardımcı Kontak (Sol) (2NO 2NC)	757,00	8	48
HDM6s100OFLX	16A~100A Yardımcı Kontak (Sağ) (1NO 1NC)	255,00	10	60
HDM6s250OFLX	125A~250A Yardımcı Kontak (Sağ) (1NO 1NC)	290,00	10	60
HDM6s400OFLX	315A~400A Yardımcı Kontak (Sağ) (1NO 1NC)	292,00	8	48
HDM6s630OFLX	500A~630A Yardımcı Kontak (Sağ) (1NO 1NC)	497,00	8	48
HDM6s100OFLX2	16A~100A Yardımcı Kontak (Sağ) (2NO 2NC)	396,00	10	60
HDM6s250OFLX2	125A~250A Yardımcı Kontak (Sağ) (2NO 2NC)	445,00	10	60
HDM6s400OFLX2	315A~400A Yardımcı Kontak (Sağ) (2NO 2NC)	445,00	8	48
HDM6s630OFLX2	500A~630A Yardımcı Kontak (Sağ) (2NO 2NC)	757,00	8	48
HDM6s100MD1N	16A~100A Motor Mekanizması AC230V	4.176,00	1	4
HDM6s250MD1N	125A~250A Motor Mekanizması AC230V	4.176,00	1	4
HDM6s400D1N	315A~400A AC Motor Mekanizması AC230V	6.257,00	1	2
HDM6s630D1N	500A~630A Motor Mekanizması AC230V	6.257,00	1	2
HDM3E800D2	HDM3E-800 Motor Mekanizması AC230V	11.893,00	1	1
HDM6s100MH2X	HDM6s-100 Kare Uzatma Kolu	564,00	2	8
HDM6s250MH2X	HDM6s-250 Kare Uzatma Kolu	661,00	2	8
HDM6s400H2XW	315A~400A Kare Uzatma Kolu (Sürgülü Tip Arkadan Bağlantı)	823,00	2	4
HDM6s630H2XW	500A~630A Kare Uzatma Kolu (Sürgülü Tip Arkadan Bağlantı)	829,00	2	2
HDM6s100LX	16A~100A Mekanik Kilit 3P	1.159,00	2	16
HDM6s250LX	125A~250A Mekanik Kilit 3P	1.274,00	2	16
HDM6s400LX	315A~400A Mekanik Kilit 3P	1.626,00	2	6
HDM6s630LX	500A~630A Mekanik Kilit 3P	1.856,00	2	6
HDM6s100MNN	16A~100A Düşük Gerilim Bobini (Sağ) AC230V 3P	970,00	6	36
HDM6s250MNN	125A~250A Düşük Gerilim Bobini (Sağ) AC230V 3P	1.060,00	6	36
HDM6s400MNN	315A~400A Düşük Gerilim Bobini (Sağ) AC230V 3P	1.561,00	4	24
HDM6s630MNN	500A~630A Düşük Gerilim Bobini (Sağ) AC230V 3P	1.700,00	4	24
HDM3E800MNA2L	HDM3E-800 Düşük Gerilim Bobini (Sol) AC230V	1.331,00	4	24



HDM6S100 Montaj Ölçüleri (mm) (16A~100A)

Montaj İçin Ön Bağlantı Ölçüleri

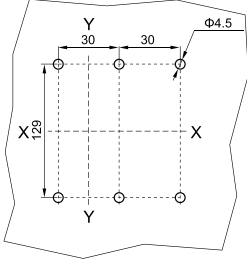

Not: X-X, Y-Y ile işaretlenmiş noktalar 3 kutuplu devre kesicinin merkezini belirtir.

Montaj İçin Arka Bağlantı Ölçüleri

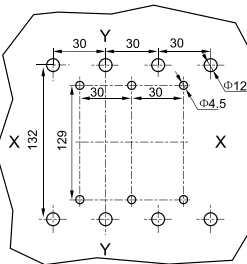

Not: X-X, Y-Y ile işaretlenmiş noktalar 3 kutuplu devre kesicinin merkezini belirtir.

Montaj Ölçüleri

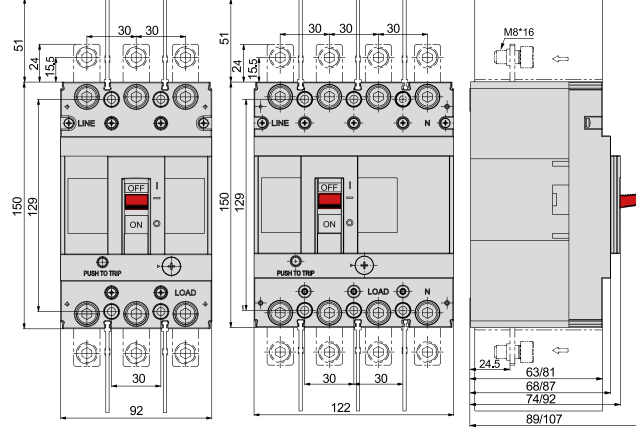

Arka Bağlantı Kablolama

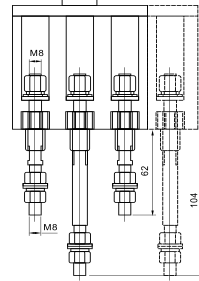

Bağlantı Terminaleri Delik Ölçüleri

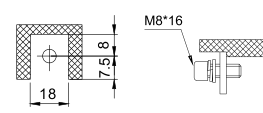

HDM6S250 Montaj Ölçüleri (mm) (125A~250A)

Montaj İçin Ön Bağlantı Ölçüleri

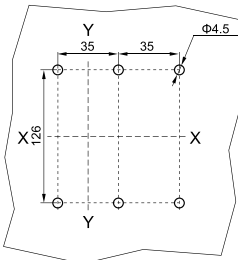

Not: X-X, Y-Y ile işaretlenmiş noktalar 3 kutuplu devre kesicinin merkezini belirtir.

Montaj İçin Arka Bağlantı Ölçüleri

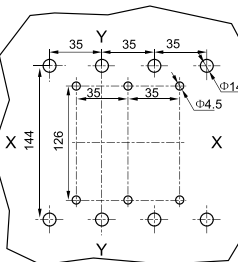

Not: X-X, Y-Y ile işaretlenmiş noktalar 3 kutuplu devre kesicinin merkezini belirtir.

Montaj Ölçüleri

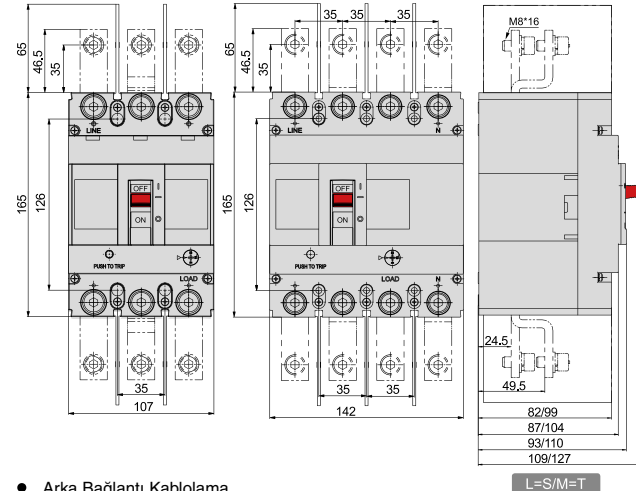

Arka Bağlantı Kablolama

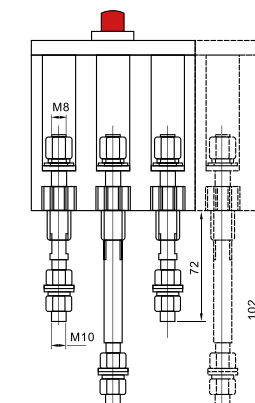

Bağlantı Terminaleri Delik Ölçüleri

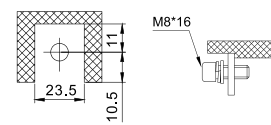

HDM6S400 Montaj Ölçüleri (mm) (315A~400A)

• Montaj İçin Ön Bağlantı Ölçüleri

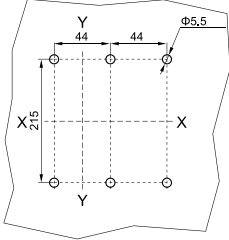

Not: X-X, Y-Y ile işaretlenmiş noktalar 3 kutuplu devre kesicinin merkezini belirtir.

• Montaj İçin Arka Bağlantı Ölçüleri

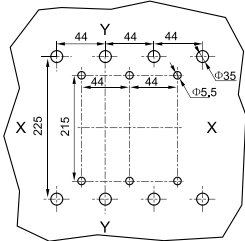

Not: X-X, Y-Y ile işaretlenmiş noktalar 3 kutuplu devre kesicinin merkezini belirtir.

• Montaj Ölçüleri

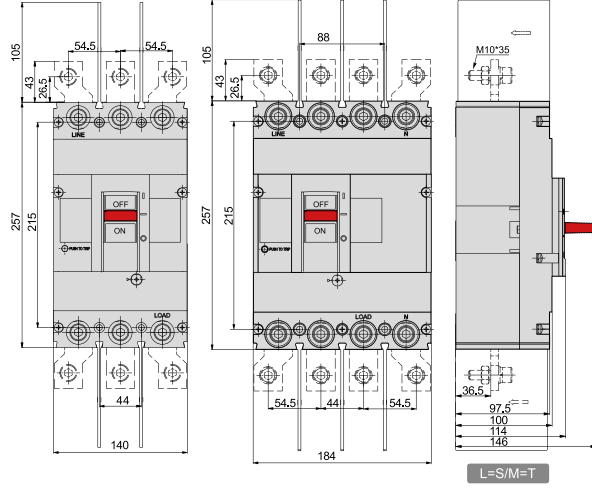

• Arka Bağlantı Kablo Lame

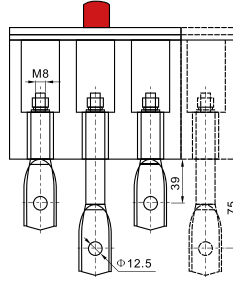

• Bağlantı Terminaleri Delik Ölçüleri

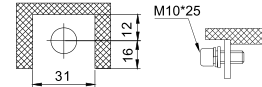

HDM6S630 Montaj Ölçüleri (mm) (500A~630A)

• Montaj İçin Ön Bağlantı Ölçüleri

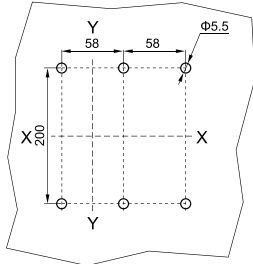

Not: X-X, Y-Y ile işaretlenmiş noktalar 3 kutuplu devre kesicinin merkezini belirtir.

• Montaj İçin Arka Bağlantı Ölçüleri

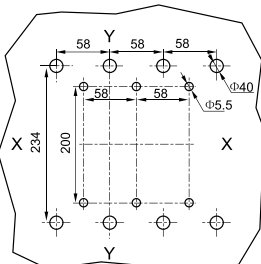

Not: X-X, Y-Y ile işaretlenmiş noktalar 3 kutuplu devre kesicinin merkezini belirtir.

• Montaj Ölçüleri

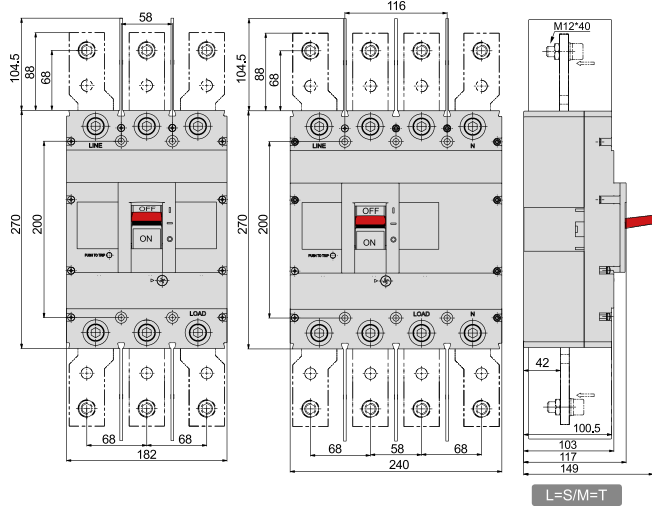

• Arka Bağlantı Kablo Lame

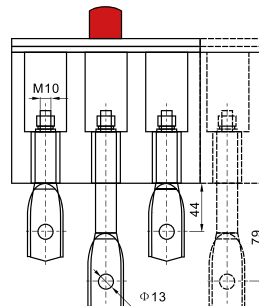

• Bağlantı Terminaleri Delik Ölçüleri

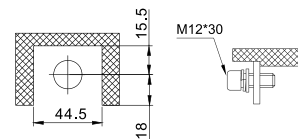

HDW3 Serisi Açık Tip Sabit Güç Şalterleri (3 Kutup)



Icu (kA)	In (A)	Referans Kodu	Yardımcı Kontak	Birim Fiyat (₺)	Kutu (Adet)	Koli (Adet)
50	800	HDW316M083FH5554M	4NO 4NC	39.589,00	1	1
50	1000	HDW316M103FH5554M	4NO 4NC	40.307,00	1	1
80	1250	HDW320M123FH5556M	6NO 6NC	44.774,00	1	1
80	1600	HDW320M163FH5556M	6NO 6NC	46.731,00	1	1
80	2000	HDW320M203FH5556M	6NO 6NC	54.604,00	1	1
80	2500	HDW332M253FH5556M	6NO 6NC	69.980,00	1	1
80	3200	HDW332M323FH5556M	6NO 6NC	78.869,00	1	1
100	*4000	HDW340M403DH5556M	6NO 6NC	FIYAT SORUNUZ	1	1

Not: * 3 Kutuplu 4000A Açık Tip Güç Şalteri çekmeceli olarak üretilir.

HDW3 Serisi Açık Tip Sabit Güç Şalterleri (4 Kutup)



Icu (kA)	In (A)	Referans Kodu	Yardımcı Kontak	Birim Fiyat (₺)	Kutu (Adet)	Koli (Adet)
50	1000	HDW316M104FHNNN4M	4NO 4NC	60.837,00	1	1
80	1250	HDW320M124FHNNN6M	6NO 6NC	61.156,00	1	1
80	1600	HDW320M164FHNNN6M	6NO 6NC	63.263,00	1	1
80	2000	HDW320M204FHNNN6M	6NO 6NC	68.899,00	1	1
80	2500	HDW332M254FHNNN6M	6NO 6NC	87.662,00	1	1
80	3200	HDW332M324FHNNN6M	6NO 6NC	101.785,00	1	1
100	*4000	HDW363M404DHNNN6M	6NO 6NC	FIYAT SORUNUZ	1	1

Not: 4 Kutuplu Açık Tip Güç Şalterlerinde AC230V Motor Mekanizması, Açırma Bobini, Düşük Gerilim Bobini standart olarak bulunur.

* 4 Kutuplu 4000A Açık Tip Güç Şalteri çekmeceli olarak üretilir.

Aksesuarlar

Referans Kodu	Açıklama	Birim Fiyat (₺)	Kutu (Adet)	Koli (Adet)
HDW3MX2A	Açırma Bobini AC230V (HDW3-1600/4000)	2.120,00	1	4
HDW3MX12A	Açırma Bobini AC230V(HDW3-2000/3200)	1.107,00	1	10
HDW3XF2A	Kapama Bobini AC230V(HDW3-1600/4000)	2.108,00	1	4
HDW3XF12A	Kapama Bobini AC230V(HDW3-2000/3200)	1.107,00	1	10
HDW3MN2A	Düşük Gerilim Bobini AC230V(HDW3-1600/4000)	2.207,00	1	4
HDW3MN12A	Düşük Gerilim Bobini AC230V(HDW3-2000/3200)	2.823,00	1	6
HDW3MNR2A	Gecikmeli Düşük Gerilim Bobini AC230V(HDW3-1600/4000)	2.149,00	1	4
HDW3MNR12A	Gecikmeli Düşük Gerilim Bobini AC230V(HDW3-2000/3200)	3.407,00	1	1
HDW3MCH162A	Motor Mekanizması AC230V(HDW3-1600)	4.548,00	1	4
HDW3MCH202A	Motor Mekanizması AC230V(HDW3-2000)	2.954,00	1	6
HDW3MCH322A	Motor Mekanizması AC230V(HDW3-3200)	3.117,00	1	1
HDW3MCH402A	Motor Mekanizması AC230V(HDW3-4000)	3.820,00	1	1
HDW316FL2	Mekanik Kilit (Kablolu Tip) (HDW3-1600)	4.220,00	1	1
HDW332FL2	Mekanik Kilit (Kablolu Tip) (HDW3-2000/3200)	4.571,00	1	1
HDW340DL2	Mekanik Kilit (Kablolu Tip) (HDW3-4000)	4.559,00	1	1

HDW3 Aksesuarlar ve Yardımcı Donanımlar

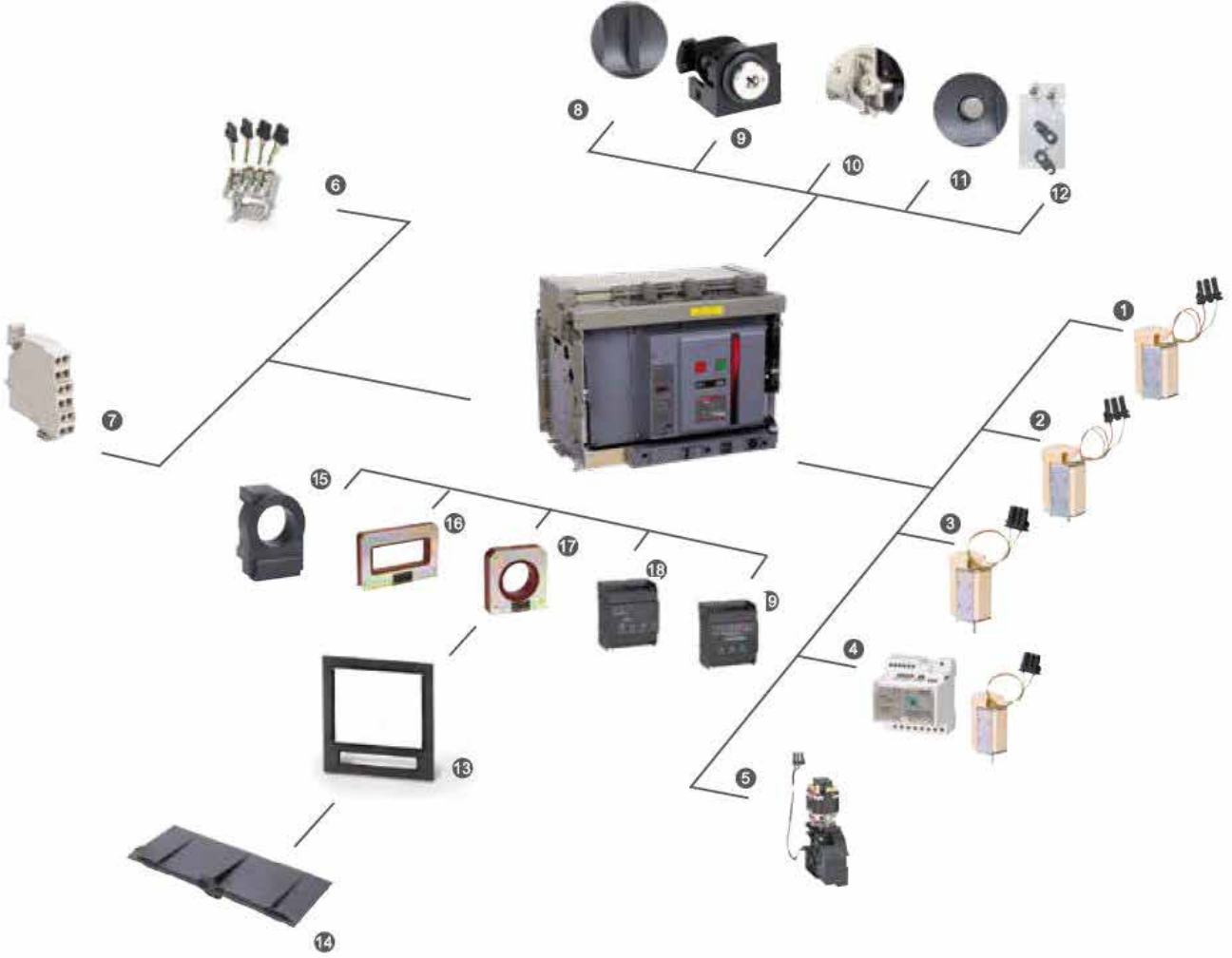

1 Açırma Bobini	6 Yardımcı Kontakt	8 Asma Kilit	13 Giriş Çerçevesi	15 N Phase Harici Trafo
2 Kapama Bobini	7 Sekonder Bağlantı Uçları	9 Anahtar Kilit	14 Seperatör	16 Kaçak Akım Trafosu
3 Düşük Gerilim Bobini		10 Giriş Kiliti		17 Toprak Trafosu
4 Gecikmeli Düşük Gerilim Bobini		11 Bağlantı, Test Klit Mekanizması		18 Güç Modülü
5 Motor Mekanizması		12 Mekanik Kilit		19 Sinyal Dönüşüm Modülü

Teknik Özellikler

Genel Devre Karakteristiği

Kutup Sayısı		3,4
Anma İzolasyon Gerilimi Ui	V	1000
Anma Darbe Dayanım Gerilimi Uimp	kV	12
Anma Gerilimi	V	400/415 660/690

Açık Tip Şalter		HDW3									
Kasa Tipi		1600M	1600S	2000M	2000S	3200M	3200S	4000M	4000S	6300M	6300S
Anma Akımı		400, 630, 800, 1000, 1250, 1600		630, 800, 1000, 1250, 1600, 2000		2000, 2500, 3200		1600, 2000, 2500, 3200, 4000		4000, 5000, 6300 (Sadece 3P)	
Kesme Kapasitesi											
Icu(kA)	400/415V	50	42	80	65	80	65	100	85	120	85
	660/690V	35	35	50	40	65	50	65	65	85	75
Ics(kA)	400/415V	42	42	65	65	65	65	85	85	100	85
	660/690V	35	35	40	40	50	50	65	65	75	75
Icw(kA)	400/415V	42	42	65	65	65	65	85	85	85	85
	660/690V	35	35	40	40	50	50	65	65	75	75
Mekanik Ömür	Bakımları Yapılmadığında	12500		15000		10000		10000		2500	
	Bakımları Yapıldığında	25000		30000		20000		20000		5000	
Elektriksel Ömür	400/415V	6000		6500		5000		5000		800	
	690V	4000		4000		3000		3000		500	
Boyut (mm) (Boy x En x Derinlik)											
Çekmeceli	3P	322*288*330		436*405*425		436*465*425		439*441*428.6		441.5*815*508	
	4P	322*358*330		436*500*425		436*580*425		439*556*428.6		441.5*930*508	
Sabit	3P	310*276*229		397*364*327		397*428*327		352*422*329.5		/	
	4P	310*346*229		397*459*327		397*543*327		352*537*329.5		/	
Ağırlık (KG)											
Çekmeceli	3P	34		73.8		93.8		78		233	
	4P	41		85.5		115		95		271.8	
Sabit	3P	14		41.4		53.4		42		/	
	4P	17		52		68		52		/	



Icu (kA)	In (A)	Referans Kodu	Ürün Adı	Birim Fiyat (₺)	Kutu (Adet)	Koli (Adet)
50 kA	40A	HDM3L12F040B320AB1	Yangın Kor.Kom.Şalter.4P B 40A 100/300/500mA	3.726,00	1	8
50 kA	50A	HDM3L12F050B320AB1	Yangın Kor.Kom.Şalter.4P B 50A 100/300/500mA	3.726,00	1	8
50 kA	63A	HDM3L12F063B320AB1	Yangın Kor.Kom.Şalter.4P B 63A 100/300/500mA	3.763,00	1	8
50 kA	80A	HDM3L12F080B320AB1	Yangın Kor.Kom.Şalter.4P B 80A 100/300/500mA	3.763,00	1	8
50 kA	100A	HDM3L12F100B320AB1	Yangın Kor.Kom.Şalter.4P B 100A 100/300/500mA	3.763,00	1	8
50 kA	125A	HDM3L25F125B320AB1	Yangın Kor.Kom.Şalter.4P B 125A 100/300/500mA	4.225,00	1	8
50 kA	160A	HDM3L25F160B320AB1	Yangın Kor.Kom.Şalter.4P B 160A 100/300/500mA	4.636,00	1	8
50 kA	180A	HDM3L25F180B320AB1	Yangın Kor.Kom.Şalter.4P B 180A 100/300/500mA	4.958,00	1	8
50 kA	200A	HDM3L25F200B320AB1	Yangın Kor.Kom.Şalter.4P B 200A 100/300/500mA	6.549,00	1	8
50 kA	225A	HDM3L25F225B320AB1	Yangın Kor.Kom.Şalter.4P B 225A 100/300/500mA	6.741,00	1	8
50 kA	250A	HDM3L25F250B320AB1	Yangın Kor.Kom.Şalter.4P B 250A 100/300/500mA	7.311,00	1	8
70 kA	315A	HDM3L40F315B320AB1	Yangın Kor.Kom.Şalter.4P B 315A 100/300/500mA	11.685,00	1	2
70 kA	350A	HDM3L40F350B320AB1	Yangın Kor.Kom.Şalter.4P B 350A 100/300/500mA	11.969,00	1	2
70 kA	400A	HDM3L40F400B320AB1	Yangın Kor.Kom.Şalter.4P B 400A 100/300/500mA	12.166,00	1	2
70 kA	500A	HDM3L63F500B320AB3	Yangın Kor.Kom.Şalter.4P B 500A 100/300/500mA	15.045,00	1	2
70 kA	630A	HDM3L63F630B320AB3	Yangın Kor.Kom.Şalter.4P B 630A 100/300/500mA	15.959,00	1	2

Not: * Ürünler açtırma bobini sol tarafa monte edilmiş şekilde kullanıma hazırdır.

* **40 A**'den **400 A**' e kadar gecikme süresi **0.1/0.2/0.3s**'dir. **500 A** ve **630 A** için gecikme süresi **0/0.2/0.5s**'dir.

* Montaj mutlaka kullanım kılavuzunda belirtildiği gibi yapılmalıdır.

Yangın Korumalı Kompakt Şalter Aksesuarları

Referans Kodu	Açıklama	Birim Fiyat (₺)	Kutu (Adet)	Koli (Adet)
HDM3L125OF11K1BR	Yardımcı kontak (sağ) HDM3L-125 1A+1K	230,00	1	1
HDM3L160OF11K1BR	Yardımcı kontak (sağ) HDM3L-160/250 1A+1K	302,00	1	1
HDM3L400OF11K1BR	Yardımcı kontak (sağ) HDM3L-400 1A+1K	384,00	1	1
HDM3L630OF11K1BR	Yardımcı kontak (sağ) HDM3L-630 1A+1K	421,00	1	1

Boyutlar

Birim: mm

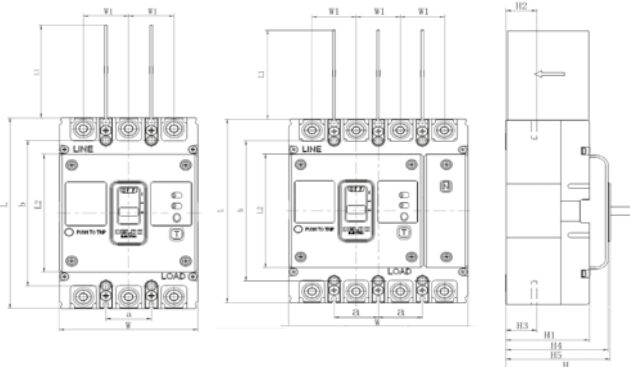

Kasa Tipi	Kutup Sayısı	Kasa Ölçüleri										Montaj Ölçüleri		
		L	L1	L2	W	W1	H	H1	H2	H3	H4	H5	a	b
125	3P	150	50	96	92	30	111.5	81	28.5	28	93.5	95.5	30	129
	4P				122									
160/250	3P	165	80	102	107	35	112.5	80	23	23	94	95.5	35	126
	4P				142									
400	3P	257	104.5	150	150	48	145.9	96.2	36	36/36.5	107.5	112.5	44	215
	4P				198									
630	3P	280	102	102	210	70	160	108	40.5	41.5	111	119	70	243
	4P				280									

Kasa Tipi	HDM3L-125	HDM3L-160	HDM3L-250	HDM3L-400	HDM3L-630
Anma Gerilimi Ue(V)	400/415	400/415	400/415	400/415	400/415
Anma Akımı In(A)	16/20/25/32/40/50/63/80/100/125	100/125/140/160	100/125/140/160/180/200/225/250	200/225/250/315/350/400	400/500/630
Anma İzolasyon Gerilimi Uimp (kV)	800	800	800	800	800
Anma Darbe Dayanım Gerilimi Uimp (kV)	8	8	8	8	8
Kutup Sayısı	3/4 (A,B)	3/4 (A,B)	3/4 (A,B)	3/4 (A,B)	3/4 (A,B)
Anma Kaçak Akım Değeri İdn mA	Gecikmesiz Tip	KA: 30mA, 100mA, 300mA	KA: 30mA, 100mA, 300mA	KB: 100mA, 300mA, 500mA	KB: 100mA, 300mA, 500mA
	Gecikmeli Tip	KB: 100mA, 300mA, 500mA	KB: 100mA, 300mA, 500mA	KB: 100mA, 300mA, 500mA	KB: 100mA, 300mA, 500mA
Anma Kaçak Akım Açma Değeri İdn0 mA	50% In	50% In	50% In	50% In	50% In
Gecikmesiz Tip Açma Süresi	≤0.2	≤0.2	≤0.2	≤0.2	≤0.2
Sabit Gecikme: 2İdn limit açma süresi (s)	0.1/0.2/0.3/0.4/0.5/1	0.1/0.2/0.3/0.4/0.5/1	0.1/0.2/0.3/0.4/0.5/1	0.1/0.2/0.3/0.4/0.5/1	-
Ayarlı Gecikme: 2İdn altında limit açma süresi (s)	Y1: 0.1/0.2/0.3s Y2: 0.4/0.5/1s	Y1: 0.1/0.2/0.3s Y2: 0.4/0.5/1s	Y1: 0.1/0.2/0.3s Y2: 0.4/0.5/1s	Y1: 0.1/0.2/0.3s Y2: 0.4/0.5/1s	0/0.2/0.5
Kesme Kapasitesi	S F	S F	S F	S F	S F
Icu (415V) 50/60Hz	35	35	35	50	50
Ics (415V) 50/60Hz	21	21	21	30	30
Anma Kaçak Akım Kesme Kapasitesi İkm (kA)	25% Icu	25% Icu	25% Icu	25% Icu	25% Icu
Mekanik Ömür(Bakımlar yapıldığında)	40000	40000	40000	20000	20000
Mekanik Ömür	20000	20000	20000	10000	10000
Elektriksel Ömür 400V	8000	8000	8000	7500	7500
Bağlantı Tipi					
Sabit, Ön Bağlantı	■	■	■	■	■
Sabit, Arka Bağlantı	■	■	■	■	■
Fiş Tipi Arka Bağlantı	■	■	■	■	■
Ölçüler (mm)	3P	107*165*94	107*165*94	150*257*107.5	210*280*111
	4P	122*150*83.5	142*165*94	198*257*107.5	210*280*111
Ürün Aksesuarları					
Açırma Bobini	■	■	■	■	■
Alarm Kontakı	■	■	■	■	■
Yardımcı Kontak (1NO-1NC)	■	■	■	/	/
Yardımcı Kontak (2NO-2NC)	■	■	■	■	■
Terminal Uzatma	■	■	■	■	■
Motor Mekanizması	■	■	■	■	■
Dairesel Uzatma Kolu	■	■	■	■	■
Kare Uzatma Kolu	■	■	■	■	■
Faz Separatörü	■	■	■	■	■
Sertifika	CE	CE	CE	CE	CE

Boy 10x38mm



Anma Akımı (A)	Referans Kodu	Birim Fiyat (₺)	Kutu (Adet)	Koli (Adet)
2A	HRT1810382	13,00	100	2400
4A	HRT1810384	13,00	100	2400
6A	HRT1810386	13,00	100	2400
8A	HRT1810388	13,00	100	2400
10A	HRT18103810	13,00	100	2400
12A	HRT18103812	13,00	100	2400
16A	HRT18103816	13,00	100	2400
20A	HRT18103820	13,00	100	2400
25A	HRT18103825	13,00	100	2400
32A	HRT18103832	13,00	100	2400



Referans Kodu	Açıklama	Birim Fiyat (₺)	Kutu (Adet)	Koli (Adet)
HRT1832Z	1 Kutup	37,00	12	288
HRT1832Z2	2 Kutup	85,00	6	144
HRT1832Z3	3 Kutup	121,00	4	96

Boy 14x51mm



Anma Akımı (A)	Referans Kodu	Birim Fiyat (₺)	Kutu (Adet)	Koli (Adet)
2A	HRT1814512	17,00	100	1000
4A	HRT1814514	17,00	100	1000
6A	HRT1814516	17,00	100	1000
8A	HRT1814518	17,00	100	1000
10A	HRT18145110	17,00	100	1000
12A	HRT18145112	17,00	100	1000
16A	HRT18145116	17,00	100	1000
20A	HRT18145120	17,00	100	1000
25A	HRT18145125	17,00	100	1000
32A	HRT18145132	17,00	100	1000
40A	HRT18145140	17,00	100	1000
50A	HRT18145150	17,00	100	1000
63A	HRT18145163	17,00	100	1000



Referans Kodu	Açıklama	Birim Fiyat (₺)	Kutu (Adet)	Koli (Adet)
HRT1863ZB	1 Kutup	85,00	6	108
HRT1863Z2B	2 Kutup	175,00	3	54
HRT1863Z3B	3 Kutup	257,00	1	36



Anma Gücü (380/400 V kW)	Anma Akımı (A)	Referans 220V AC	Referans 24V AC	Yard. Kontak	Birim Fiyat (₺)	Kutu (Adet)	Koli (Adet)
4 kW	9A	HDC60911M	HDC60911B	1NO 1NC	264,00	1	60
5,5 kW	12A	HDC61211M	HDC61211B	1NO 1NC	282,00	1	60
7,5 kW	18A	HDC61811M	HDC61811B	1NO 1NC	330,00	1	60
11 kW	25A	HDC62511M	HDC62511B	1NO 1NC	443,00	1	18
15 kW	32A	HDC63211M	HDC63211B	1NO 1NC	668,00	1	18
18,5 kW	40A	HDC64011M	HDC64011B	1NO 1NC	1.095,00	1	8
22 kW	50A	HDC65011M	HDC65011B	1NO 1NC	1.294,00	1	8
30 kW	65A	HDC66511M	HDC66511B	1NO 1NC	1.600,00	1	8
37 kW	80A	HDC68011M	HDC68011B	1NO 1NC	2.112,00	1	6
45 kW	95A	HDC69511M	HDC69511B	1NO 1NC	2.298,00	1	6
55 kW	115A	HDC611500M	-	-	4.199,00	1	4
75 kW	150A	HDC615000M	-	-	4.428,00	1	4
90 kW	185A	HDC618500M	-	-	6.054,00	1	4
110 kW	225A	HDC622500M	-	-	6.958,00	1	4
132 kW	265A	HDC626500M	-	-	8.102,00	1	1
160 kW	330A	HDC633000M	-	-	11.638,00	1	1
200 kW	400A	HDC640000M	-	-	11.852,00	1	1
250 kW	500A	HDC650000M	-	-	19.340,00	1	1
335 kW	630A	HDC663000M	-	-	24.494,00	1	1

Boyutlar Birim: mm

HDC6-9~32

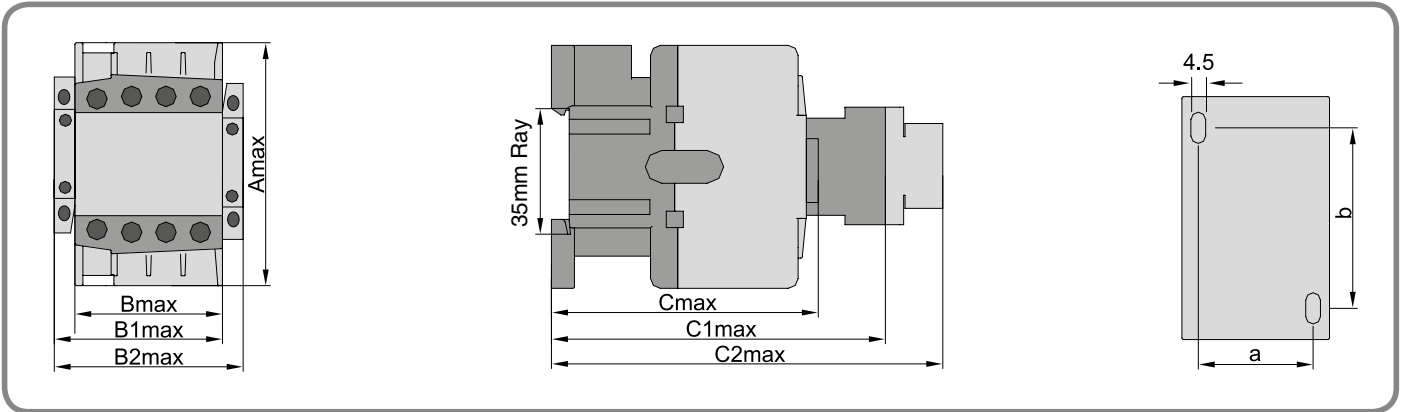

HDC6	9/12	18	25/32
A	74.5	74.5	80
B (Aksesuarsız)	45.5	45.5	56.5
B1 (Kontaktör + HFC6)	58	58	69
B2 (Kontaktör + İki HFC6)	71	71	82
C (Aksesuarsız)	84	89	99.5
C1 (Kontaktör + HFD6)	116	122	132
C2 (Kontaktör + HFT6)	141	145	156
a	35	35	40
b	50/60	50/60	50/70

HDC6-40~95

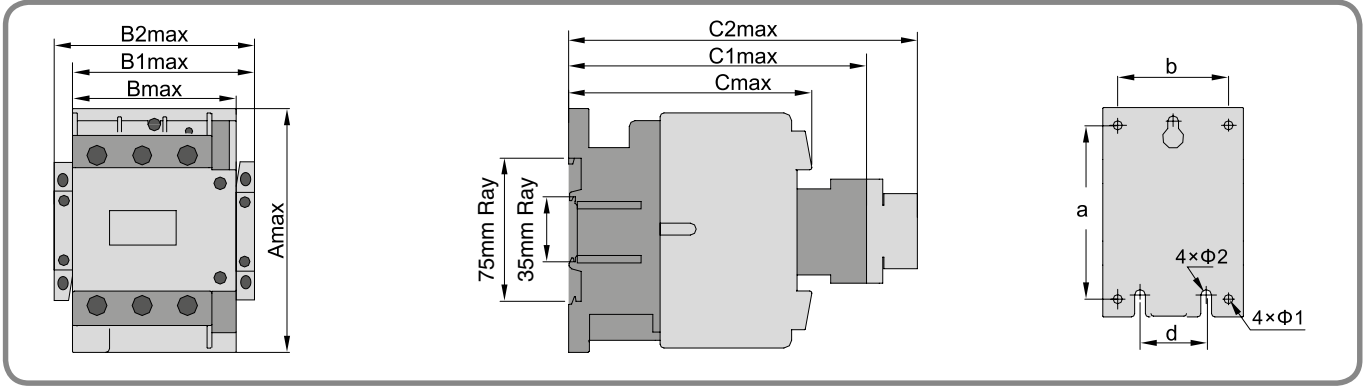

HDC6	40/50/65	80/95
A	127	127
B (Aksesuarsız)	75	85
B1 (Kontaktör + HFC6)	89	99
B2 (Kontaktör + İki HFC6)	102	112
C (Aksesuarsız)	118.5	127.5
C1 (Kontaktör + HFD6)	150	160
C2 (Kontaktör + HFT6)	175	185
a	105	105
b	59	67
c	105	105
d	40	40
φ1	5.5	5.5
2	6.5	6.5

HDC6-115~330

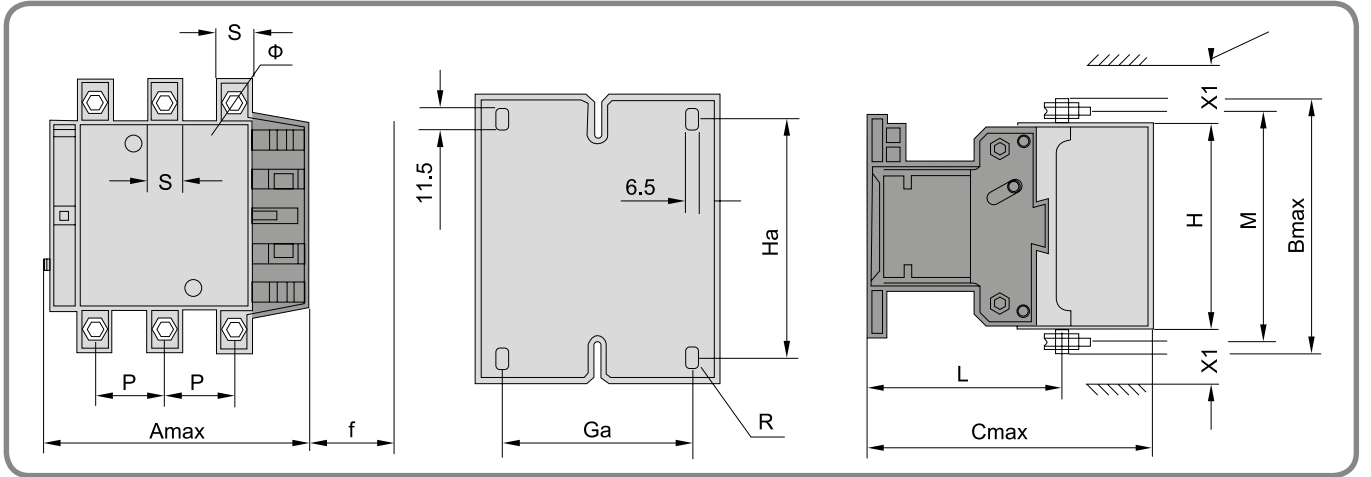

Model	Amax	Bmax	Cmax	P	S	φ	f	M	H	L	X1		Ga	Ha
											(200-550V)	(600-1000V)		
HDC6-115	167	163	172	37	20	M6	131	147	124	107	10	15	80	110~120
HDC6-150	167	171	172	40	20	M8	131	150	124	107	10	15	80	110~120
HDC6-185	171	174	183	40	20	M8	131	154	127	113.5	10	15	80	110~120
HDC6-225	171	197	183	48	25	M10	131	172	127	113.5	10	15	80	110~120
HDC6-265	202	203	215	48	25	M10	147	178	147	141	10	15	96	110~120
HDC6-330	213	206	220	48	25	M10	147	181	158	145	10	15	96	110~120

HDC6-400~500

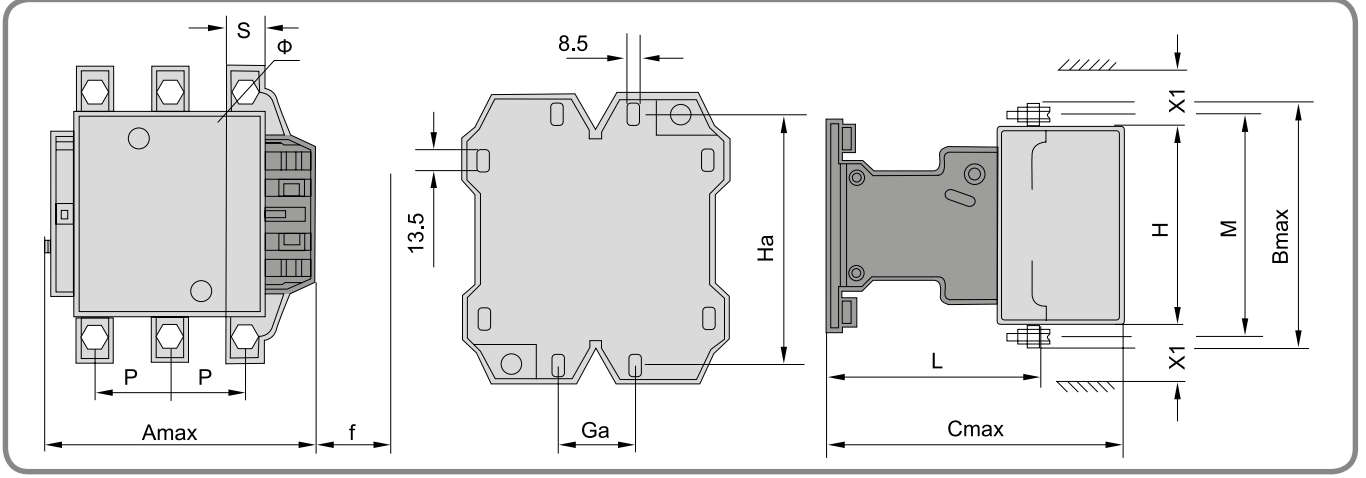

Model	Amax	Bmax	Cmax	P	S	φ	f	M	H	L	X1	X1	Ga	Ha
											(200-550V)	(600-1000V)		
HDC6-400	213	206	220	48	25	M10	146	181	158	145	15	20	80	170~180
HDC6-500	223	233	233	55	30	M10	150	208	172	146	15	20	80	170~180

HDC6-630

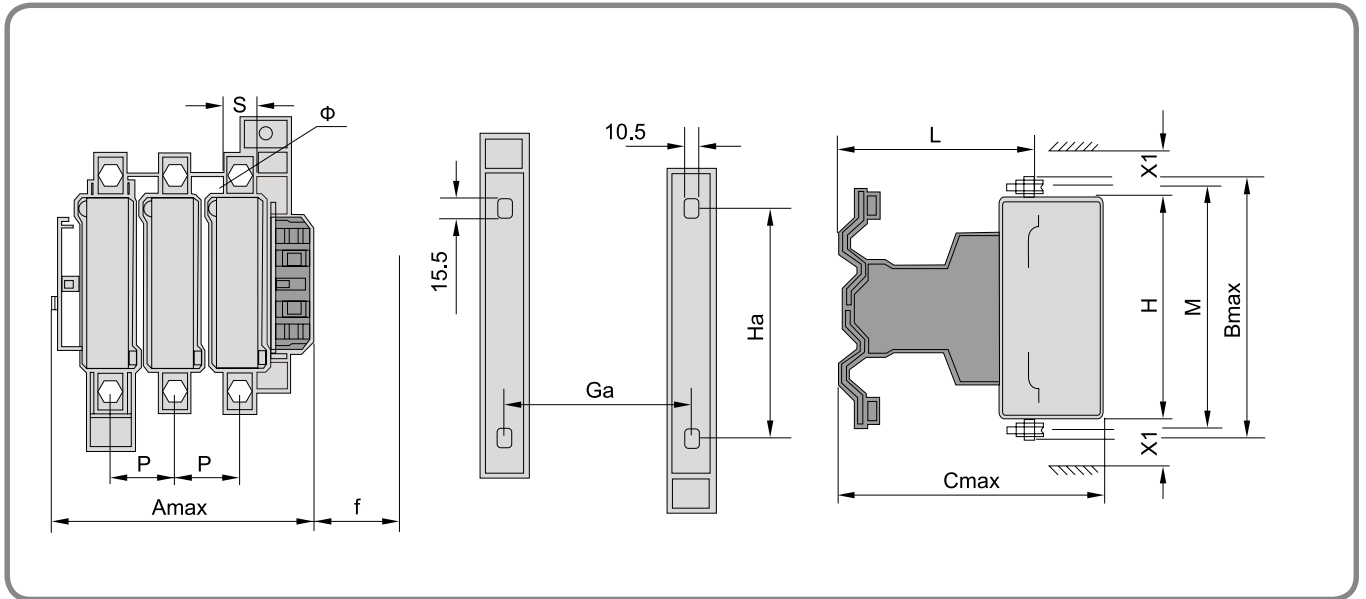

Model	Amax	Bmax	Cmax	P	S	φ	f	M	H	L	X1	X1	Ga	Ha
											(200-550V)	(600-1000V)		
HDC6-630	309	304	256	80	40	M12	181	264	202	155	20	30	180	180~190

Teknik Özellikler

Model		HDC6-09	HDC6-12	HDC6-18	HDC6-25	HDC6-32	HDC6-40	HDC6-50	HDC6-65	HDC6-80	HDC6-95
Genel Devre Karakteristiği											
Anma İşletme Akımı	le, AC-3 le, AC-1	9 A 20 A	12 A 20 A	18 A 32 A	25 A 40 A	32 A 50 A	40 A 60 A	50 A 80 A	65 A 80 A	80 A 125 A	95 A 125 A
Anma İzolasyon Gerilimi (Ui)		690V									
Anma İşletme Gerilimi (Ue)		690V									
Kutup Sayısı		3									
Anma İşletme Gücü (kW)	220/240V 380/400V 415/440V 660/690V	2.2kW 4 kW 4 kW 5.5kW	3 kW 5.5kW 5.5kW 7.5kW	4 kW 7.5kW 9 kW 10 kW	5.5kW 11 kW 11 kW 15 kW	7.5kW 15 kW 15 kW 18.5kW	11 kW 18.5kW 22 kW 30 kW	15 kW 22 kW 25 kW 33 kW	18.5kW 30 kW 37 kW 37 kW	22 kW 37 kW 45 kW 45 kW	25 kW 45 kW 45 kW 45 kW
AC-3	Elektriksel Ömür (10000 aç-kapa) İşletme Oranı (Süre/saat)	100 1200	100 1200	100 1200	100 1200	80 600	80 600	80 600	80 600	60 600	60 600
Mekanik Ömür	(10000 aç-kapa)	1000	1000	1000	1000	800	800	800	800	800	800
Bobin											
Anma Bobin Gerilimi (Us)	50Hz 50/60Hz	24V,36V,48V,110V,127V,220V,380V,400V,415V,440V 24V,36V,48V,110V,220V,230V,240V,380V,400V									
Bobin İşletme Gerilim Aralığı (Us)	Devrede Devre Dışı	85%–110% Us 20%–75% Us									
Bobin Gücü	İçeride VA Kapalı VA Isı Yayımları W	70 8 1.8–2.7			110 11 3–4		200 20 6–10				
Kablolama											
Çok Tellli İletken (Papuçsuz)	1 Adet (Terminalerde mm²)	1–4	1–4	1.5–6	1.5–10	2.5–10	2.5–25	2.5–25	2.5–25	4–50	4–50
	2 Adet (Terminalerde mm²)	1–4	1–4	1.5–6	1.5–6	2.5–10	2.5–16	2.5–16	2.5–16	4–25	4–25
Çok Tellli İletken (Papuçsuz)	1 Adet (Terminalerde mm²)	1–4	1–4	1–6	1–6	1–10	2.5–25	2.5–25	2.5–25	4–50	4–50
	2 Adet (Terminalerde mm²)	1–2.5	1–2.5	1–4	1–4	1.5–6	2.5–10	2.5–10	2.5–10	4–16	4–16
Tek Tellli İletken (Papuçsuz)	1 Adet (Terminalerde mm²)	1–4	1–4	1.5–6	1.5–6	1.5–10	2.5–25	2.5–25	2.5–25	4–50	4–50
	2 Adet (Terminalerde mm²)	1–4	1–4	1.5–6	1.5–6	2.5–10	2.5–16	2.5–16	2.5–16	4–25	4–25
Yardımcı Kontak											
Anma Termik Akımı(Ith)	A	10									
Anma İşletme Gerilimi (Ue)	AC V DC V	400 230									
Anma Kontrol Kapasitesi	AC-15 VA DC-13 W	360 33									
Model		HDC6-115	HDC6-150	HDC6-185	HDC6-225	HDC6-265	HDC6-330	HDC6-400	HDC6-500	HDC6-630	
Anma İşletme Akımı	le, AC-3 le, AC-1	115 A 200 A	150 A 200 A	185 A 275 A	225 A 275 A	265 A 315 A	330 A 380 A	400 A 450 A	500 A 630 A	630 A 800 A	
Anma İzolasyon Gerilimi (Ui)		1000V									
Anma İşletme Gerilimi (Ue)		690V									
Kutup Sayısı		3									
Anma İşletme Gücü (kW)	220/240V 380/400V 415/440V 660/690V	30 kW 55 kW 59 kW 80 kW	40 kW 75 kW 80 kW 100kW	55 kW 90kW 100kW 110kW	63 kW 110kW 110kW 129kW	75 kW 132kW 140kW 160kW	100kW 160kW 180kW 220kW	110kW 200kW 220kW 280kW	147kW 250kW 280kW 335kW	200kW 335kW 375kW 450kW	
AC-3	Elektriksel Ömür (10000 aç-kapa) İşletme Oranı (Süre/saat)	120 600	120 600	100 600	100 600	80 600	80 600	80 300	80 300	80 300	
Mekanik Ömür	(10000 aç-kapa)	1000	1000	600	600	600	600	600	600	600	
Bobin											
Anma Bobin Gerilimi (Us)	50Hz 50/60Hz	110V,127V,220V,230V,240V,380V,400V,440V 110V,220V,380V (115-225AF)									
Bobin İşletme Gerilim Aralığı (Us)	Devrede Devre Dışı	85%–110% Us 20%–75% Us									
Bobin Gücü	İçeride VA Kapalı VA Isı Yayımları W	550 45 16		800 55 24		1200 13 12		1200 20 14	1250 24 18	1650 22 20	
Kablolama											
Tek Tellli İletken (Papuçsuz)	1 Adet (Terminalerde mm²)	95	120	150	185	240	240	-	-	-	
	2 Adet (Terminalerde mm²)	-	-	-	-	-	-	150	240	-	
Bakır Bara	2 Adet (Ölçü mm²)	20*3	25*3	25*3	32*4	32*4	30*5	30*5	40*5	60*5	
Yardımcı Kontak											
Anma Termik Akımı(Ith)	A	10									
Anma İşletme Gerilimi (Ue)	AC V DC V	400 230									
Anma Kontrol Kapasitesi	AC-15 VA DC-13 W	360 33									

HDC6-9~95A

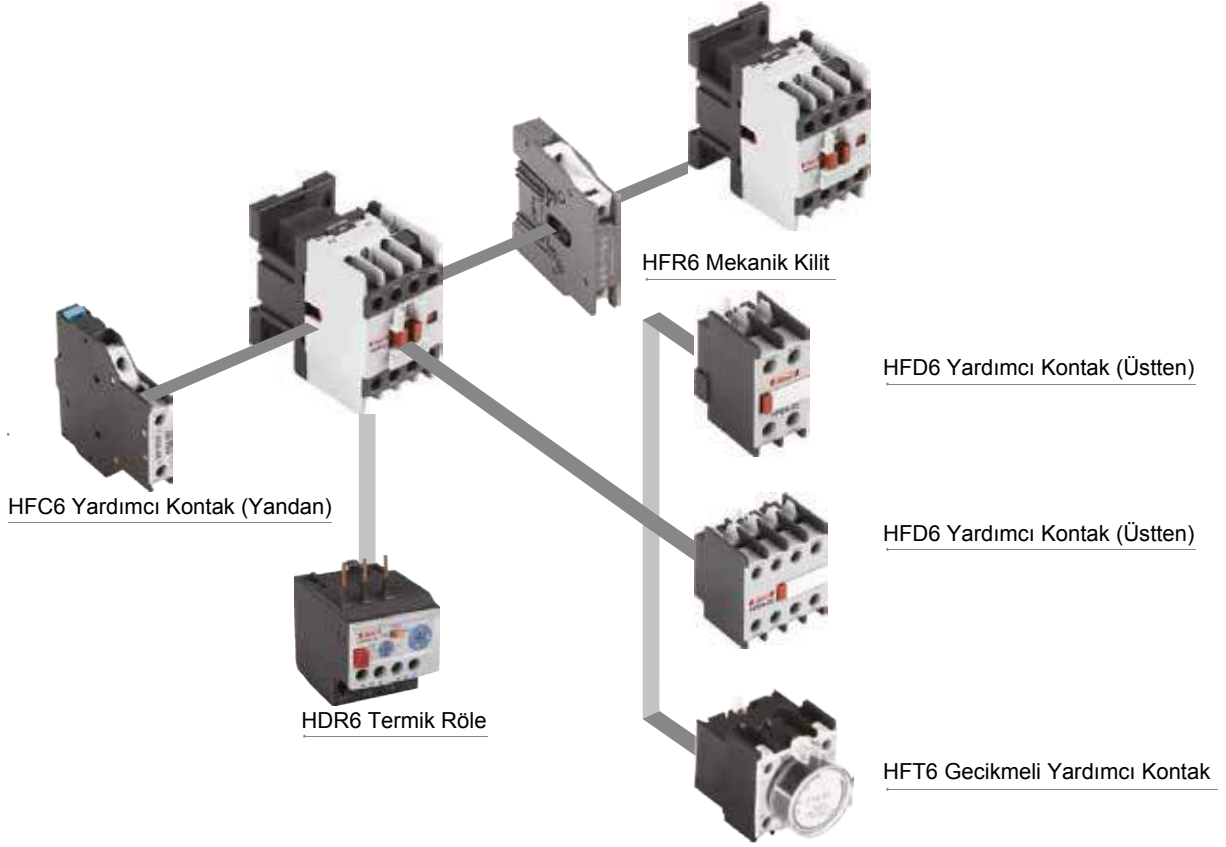

Referans Kodu	Açıklama	Birim Fiyat (₺)	Kutu (Adet)	Koli (Adet)
HFT634	Açmada Gecikmeli Yard.Kontak 10-180S (9A~630A)	431,00	1	70
HFT632	Açmada Gecikmeli Yard.Kontak 0.1-30S (9A~630A)	431,00	1	70
HFT630	Açmada Gecikmeli Yard.Kontak 0.1-3S (9A~630A)	431,00	1	70
HFT624	Kapatmada Gecikmeli Yard.Kontak 10-180S (9A~630A)	431,00	1	70
HFT622	Kapatmada Gecikmeli Yard.Kontak 0.1-30S (9A~630A)	431,00	1	70
HFT620	Kapatmada Gecikmeli Yard.Kontak 0.1-3S (9A~630A)	431,00	1	70
HFD640	Üstten Yardımcı Kont. 4NO (9A~630A)	138,00	6	102
HFD631	Üstten Yardımcı Kont. 3NO 1NC (9A~630A)	138,00	6	102
HFD622	Üstten Yardımcı Kont. 2NO 2NC (9A~630A)	138,00	6	102
HFD613	Üstten Yardımcı Kont. 1NO 3NC (9A~630A)	138,00	6	102
HFD604	Üstten Yardımcı Kont. 4NC (9A~630A)	138,00	6	102
HFD611	Üstten Yardımcı Kont. 1NO 1NC (9A~630A)	95,00	10	170
HFD620	Üstten Yardımcı Kont. 2NO (9A~630A)	91,00	10	170
HFD602	Üstten Yardımcı Kont. 2NC (9A~630A)	95,00	10	170
HFC620	Yandan Yardımcı Kont. 2NO (9A~95A)	140,00	1	60
HFC611	Yandan Yardımcı Kont. 1NO 1NC (9A~95A)	140,00	1	60
HFC602	Yandan Yardımcı Kont. 2NC (9A~95A)	140,00	1	60

YEDEK BOBİNLER



Referans	Berber Kullanılacak Kontaktör	Birim Fiyat (₺)	Kutu (Adet)	Koli (Adet)
HX6150M	HDC6-115~150A 220V 50Hz	892,00	1	12
HX6225M	HDC6-185~225A 220V 50Hz	1.249,00	1	12
HX6330M	HDC6-265~330A 220V 50Hz	2.073,00	1	12
HX6400M	HDC6-400A 220V 50Hz	2.799,00	1	6
HX6500M	HDC6-500A 220V 50Hz	3.301,00	1	4
HX6630M	HDC6-630A 220V 50Hz	4.781,00	1	4
HX618B	HDC6-9/18A 24V 50Hz	109,00	2	80
HX618E	HDC6-9/18A 48V 50Hz	109,00	2	80
HX618F	HDC6-9/18A 110V 50Hz	109,00	2	80
HX618Q	HDC6-9/18A 380V 50Hz	109,00	2	80
HX632B	HDC6-25/32A 24V 50Hz	156,00	1	40
HX632E	HDC6-25/32A 48V 50Hz	156,00	1	40
HX632F	HDC6-25/32A 110V 50Hz	156,00	1	40
HX632Q	HDC6-25/32A 380V 50Hz	156,00	1	40
HX665B	HDC6-40/65A 24V 50Hz	175,00	1	18
HX665E	HDC6-40/65A 48V 50Hz	210,00	1	18
HX665F	HDC6-40/65A 110V 50Hz	175,00	1	18
HX665Q	HDC6-40/65A 380V 50Hz	175,00	1	18
HX695B	HDC6-80/95A 24V 50Hz	220,00	1	18
HX695E	HDC6-80/95A 48V 50Hz	220,00	1	18
HX695F	HDC6-80/95A 110V 50Hz	220,00	1	18
HX695Q	HDC6-80/95A 380V 50Hz	220,00	1	18
HFR632H	Mekanik kilit (9A~32A)	228,00	1	60
HFR695H	Mekanik kilit (40A~95A)	300,00	1	60
HFR6FFHs	Mekanik kilit (115A~150A)	228,00	1	60
HFR6GGHs	Mekanik kilit (185A~225A)	228,00	1	60
HFR6HHHs	Mekanik kilit (265A~330A)	228,00	1	60
HFR6KKHs	Mekanik kilit (400A~500A)	228,00	1	60
HFR6LLHs	Mekanik kilit (630A)	228,00	1	60

MEKANİK KİLİT





Ayar Sahası	Beraber Kullanılacak Kontaktör	Referans	Birim Fiyat (₺)	Kutu (Adet)	Koli (Adet)
0,10~0,15A	HDC6-9~18A	HDR618P15	440,00	1	90
0,12~0,18A	HDC6-9~18A	HDR618P18	440,00	1	90
0,18~0,25A	HDC6-9~18A	HDR618P25	440,00	1	90
0,25~0,36A	HDC6-9~18A	HDR618P36	440,00	1	90
0,35~0,50A	HDC6-9~18A	HDR618P5	440,00	1	90
0,50~0,70A	HDC6-9~18A	HDR618P7	440,00	1	90
0,63~0,90A	HDC6-9~18A	HDR618P9	440,00	1	90
0,90~1,20A	HDC6-9~18A	HDR6181P2	440,00	1	90
1,20~1,80A	HDC6-9~18A	HDR6181P8	440,00	1	90
1,80~2,50A	HDC6-9~18A	HDR6182P5	440,00	1	90
2,50~3,60A	HDC6-9~18A	HDR6183P6	440,00	1	90
3,50~4,80A	HDC6-9~18A	HDR6184P8	440,00	1	90
4,50~6,30A	HDC6-9~18A	HDR6186P3	440,00	1	90
5~7A	HDC6-9~18A	HDR6187	440,00	1	90
6,3~9A	HDC6-9~18A	HDR6189	440,00	1	90
9~12A	HDC6-9~18A	HDR61812	440,00	1	90
11~15A	HDC6-9~18A	HDR61815	440,00	1	90
14~18A	HDC6-9~18A	HDR61818	440,00	1	90
6,3~9A	HDC6-25~32A	HDR6329	553,00	1	18
9~12A	HDC6-25~32A	HDR63212	553,00	1	18
14~18A	HDC6-25~32A	HDR63218	591,00	1	18
18~25A	HDC6-25~32A	HDR63225	612,00	1	18
23~32A	HDC6-25~32A	HDR63232	612,00	1	18
18~25A	HDC6-40~95A	HDR69525	961,00	1	27
23~32A	HDC6-40~95A	HDR69532	961,00	1	27
30~40A	HDC6-40~95A	HDR69540	993,00	1	27
37~50A	HDC6-40~95A	HDR69550	1.024,00	1	27
48~65A	HDC6-40~95A	HDR69565	1.037,00	1	27
55~70A	HDC6-40~95A	HDR69570	1.199,00	1	27
63~80A	HDC6-40~95A	HDR69580	1.284,00	1	27
80~95A	HDC6-40~95A	HDR69595	1.284,00	1	27
48~65A	HDC6-185 115-185A	HDR618565	1.462,00	1	12
55~70A	HDC6-185 115-185A	HDR618570	1.462,00	1	12
63~80A	HDC6-185 115-185A	HDR618580	1.530,00	1	12
75~95A	HDC6-185 115-185A	HDR618595	1.545,00	1	12
90~115A	HDC6-185 115-185A	HDR6185115	1.566,00	1	12
105~135A	HDC6-185 115-185A	HDR6185135	1.598,00	1	12
120~150A	HDC6-185 115-185A	HDR6185150	1.658,00	1	12
130~160A	HDC6-185 115-185A	HDR6185160	1.658,00	1	12
150~185A	HDC6-185 115-185A	HDR6185185	1.658,00	1	12
145~200A	HDC6-630 225-630A	HDR6630200F	3.848,00	1	2
180~250A	HDC6-630 225-630A	HDR6630250F	3.848,00	1	2
230~320A	HDC6-630 225-630A	HDR6630320F	3.839,00	1	2
290~400A	HDC6-630 225-630A	HDR6630400F	3.839,00	1	2
350~480A	HDC6-630 225-630A	HDR6630480F	3.839,00	1	2
460~630A	HDC6-630 225-630A	HDR6630630F	3.839,00	1	2



Ray Tipi Termik Röleler

Referans Kodu	Açıklama	Birim Fiyat (₺)	Kutu (Adet)	Koli (Adet)
HJRS2634F	2.5~4A Ray Tipi Termik Röle	396,00	1	48
HJRS2636P3F	4~6.3A Ray Tipi Termik Röle	396,00	1	48
HJRS26310F	6.3~10A Ray Tipi Termik Röle	396,00	1	48
HJRS26316F	10~16A Ray Tipi Termik Röle	396,00	1	48
HJRS26325F	16~25A Ray Tipi Termik Röle	396,00	1	48
HJRS26340F	25~40A Ray Tipi Termik Röle	559,00	1	48
HJRS26357F	40~57A Ray Tipi Termik Röle	559,00	1	48
HJRS26363F	50~63A Ray Tipi Termik Röle	559,00	1	48





Berber Kullanılacak Termik	Referans	Birim Fiyat (₺)	Kutu (Adet)	Koli (Adet)
HDR6-18 0,10~18A	HDR618J	31,00	2	66
HDR6-32 6,3~32A	HDR632J	44,00	2	36
HDR6-95 18~95A	HDR695J	97,00	2	24

HDR6 Termik Röle Teknik Özellikleri

	HDR6-18	HDR6-32	HDR6-95
Açma Sınıfı	10A	10A	10
Tip Akımı	18A	32A	95A
Anma İzolasyon Gerilimi	690V	690V	690V
Faz Hata Koruma	Var	Var	Var
Manuel ve Otomatik Reset	Var	Var	Var
Açma Kapama Bildirimi	Var	Var	Var
Stop Butonu	Var	Var	Var
Test Butonu	Var	Var	Var
Isı Dengeleme	Var	Var	Var
Kurulum Şekli	Geçmeli/Bağımsız	Geçmeli/Bağımsız	Geçmeli/Bağımsız
Kablolama			
Ana Devre	Terminal Kapasitesi	1~4mm ²	1~4mm ²
	Maks. Tork	1.2N·m	1.7N·m
Yardımcı Devre	Terminal Kapasitesi	1mm ²	1mm ²
	Maks. Tork	1.2N·m	1.2N·m

İşletme Özellikleri

No.	Farklı Akımlarda	İşletme Süresi		Başlama Koşulu	Ortam Sıcaklığı
		Açma Sınıfı 10A	Açma Sınıfı 10A		
Dengeli faz yüküne göre işletme özellikleri					
1	1.05	Devre Dışı (2 saat içerisinde)	Devre Dışı (2 saat içerisinde)	Soğuk Çalıştırma	+20°C
2	1.2	Devrede (2 saat içerisinde)	Devrede (2 saat içerisinde)	Sıcak Çalıştırma (1. Testten sonra)	
3	1.5	< 2 dakika	< 4 dakika	Sıcak Çalıştırma (1. Testten sonra)	
4	7.2	2s < Tp ≤ 10s	4s < Tp ≤ 10s	Soğuk Çalıştırma	+20°C
Dengesiz faz yüküne göre işletme özellikleri					
Her hangi 2 faz, 3. faz					
1	1.0	0.9	Devre Dışı (2 saat içerisinde)	Devre Dışı (2 saat içerisinde)	Soğuk Çalıştırma
2	1.15	0	Devrede (2 saat içerisinde)	Devrede (2 saat içerisinde)	Sıcak Çalıştırma (1. Testten sonra)



Referans	Güç (Kw) AC-3 380/400V	Anma Akımı (A) AC-3 380/400V	Güç (Kw) AC-1 380/400V	Anma Akımı (A) AC-1 380/400V	Birim Fiyat (₺)	Kutu (Adet)	Koli (Adet)
HJX20904M7	4 kW	9A	13,5kW	25A	328,00	1	50
HJX21204M7	5,5 kW	12A	13,5kW	25A	349,00	1	50
HJX22504M7	11 kW	25A	21,8kW	40A	579,00	1	40
HJX24004M7	18,5 kW	40A	32,6kW	60A	1.645,00	1	12
HJX25004M7	22 kW	50A	43,5kW	80A	1.811,00	1	12
HJX26504M7	30 kW	65A	43,5kW	80A	2.057,00	1	12
HJX28004M7	37 kW	80A	64,7kW	125A	2.793,00	1	10
HJX29504M7	45 kW	95A	64,7kW	125A	2.905,00	1	10
HJX2F1154M7	55 kW	115A	120kW	200A	6.001,00	1	4
HJX2F1504M7	75 kW	150A	140kW	250A	6.390,00	1	4
HJX2F1854M7	90 kW	185A	165kW	275A	8.213,00	1	4
HJX2F2254M7	100 kW	225A	175kW	315A	8.453,00	1	2
HJX2F2654M7	132 kW	265A	210kW	350A	12.372,00	1	2
HJX2F3304M7	160 kW	330A	250kW	400A	16.794,00	1	2
HJX2F4004M7	200 kW	400A	300kW	500A	17.409,00	1	2
HJX2F5004M7	250 kW	500A	430kW	630A	23.336,00	1	2
HJX2F6304M7	335 kW	630A	600kW	800A	32.704,00	1	1
HJX2F8004M7	400 kW	800A	600kW	800A	38.061,00	1	1

Teknik Özellikler

Model	HJX2-F115	HJX2-F150	HJX2-F185	HJX2-F225	HJX2-F265	HJX2-F330	HJX2-F400	HJX2-F500	HJX2-F630	HJX2-F800	
Genel Devre Karakteristikleri											
Anma İşletme Gerilimi Ue	380/400V, 660/690V										
Anma İzolasyon Gerilimi Ui	690V										
Anma Darbe Dayanım Gerilimi Uimp	8kV										
Anma İşletme Akımı	440V AC-3 A	115	150	185	225	265	330	400	500	630	800
	440V AC-4 A	52	60	79	85	105	117	138	147	188	195
	660V AC-3 A	86	107	118	135	170	235	305	355	460	493
	660V AC-4 A	49	57	69	82	98	107	135	145	170	175
	Ie max AC-1 A θ ≤ 40 °C	200	250	275	315	350	400	500	630	800	800
Anma Gücü Sınıf AC-3	220/240V	30	40	55	63	75	100	129	147	200	220
	380/400V	55	75	90	100	132	160	200	250	335	400
	415V	59	80	100	110	140	180	220	280	375	425
	440V	59	80	100	110	140	180	220	280	375	425
	500V	75	90	110	129	160	200	257	335	400	450
	660/690V	80	100	120	129	180	220	280	355	450	475
	1000V	65	65	100	140	147	160	185	335	450	450
Elektriksel Dayanım	AC-3 x 10 ⁴	60	60	50	50	50	50	30	30	20	15
	AC-4 x 10 ⁴	15	15	15	15	15	15	8	8	5	4
Mekanik Dayanım	x 10 ⁴	300	300	300	300	300	300	100	100	100	100
İşletme Hızı Tur/sa	AC-1, AC-2, AC-3	600	600	600	600	600	600	300	300	300	300
	AC-4	150	150	150	150	150	150	150	150	150	150
Kablo bağlantı kesiti mm ²		95	120	150	185	240	240	2*150	2*240	2*60*5	2*60*5

Boyutlar Birim: mm

HJX2-09~25

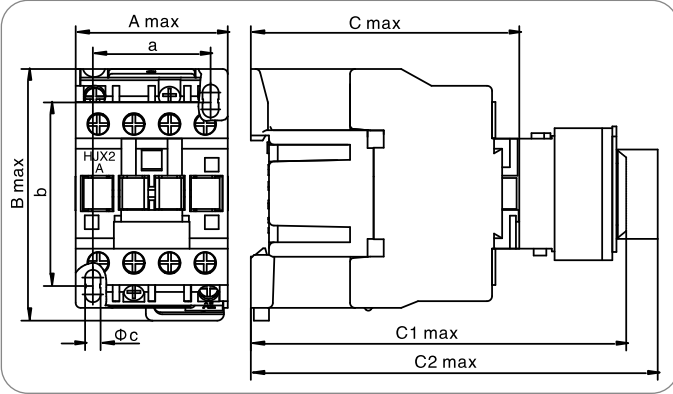

HJX2-40~95

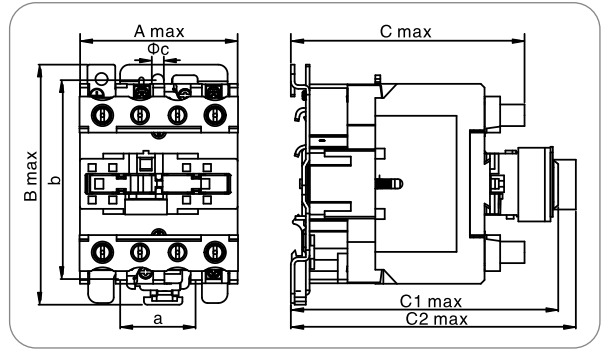
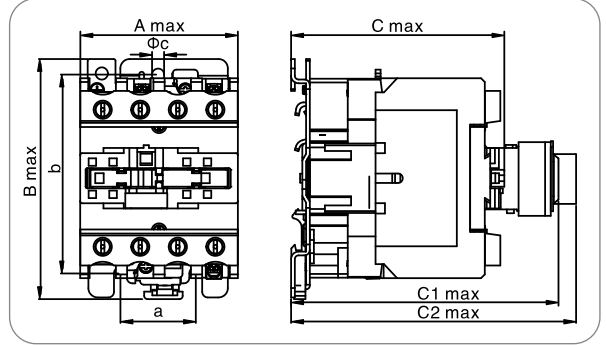

Model	A max	B max	C max	C1 max	C2 max	a	b	c
HJX2-0904,0908,1204,1208	47	76	82	115	134	35	50/60	4.5
HJX2-2504,2508	58	86	96	130	149	40	50/60	4.5
HJX2-4004,5004,6504	85	128	116	149	168	40	100/110	6.5
HJX2-4008,5008,6508	85	128	126	149	168	40	100/110	6.5
HJX2-8004,9504	96	128	127	160	179	40	100/110	6.5
HJX2-8008,9508	96	128	136	160	179	40	100/110	6.5

Not: C1max – Kontaktör+HF4(veya HFD6) C2max – Kontaktör+HSK4(veya HFT6)

HJX2-F115~330

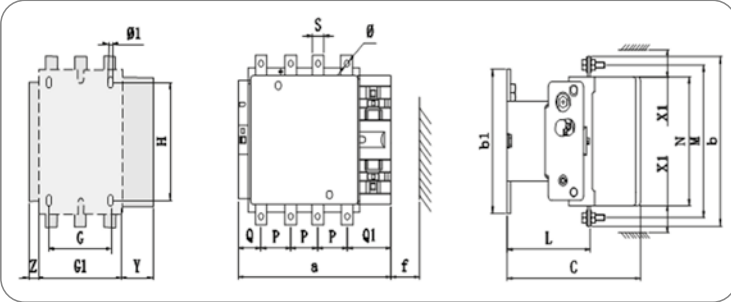

HJX2-F400~500

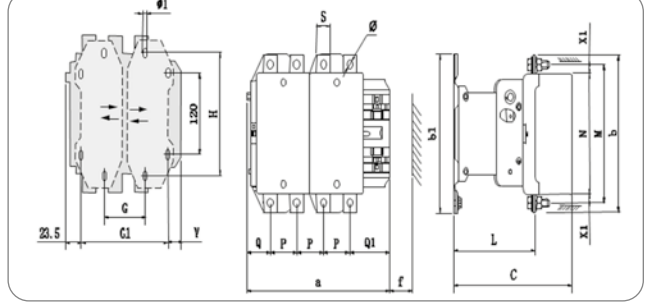

HJX2-F630~800

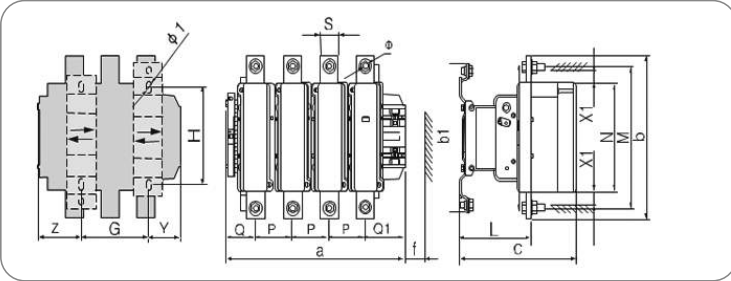

HJX2-F	a	P	Q	Q1	S	φ	f	b	b1	M	N	C	L	G	H	φ1	G1	Z	Y	X1	
																				500V >500V	
1154	220.5	37	29.5	60	20	M6	131	162	137	147	124	171	107	80	120-106	6.5	143	13.5	44	10	15
1504	200.5	40	25	55.5	20	M8	131	170	137	150	124	171	113.5	80	120-106	6.5	143	13.5	44	10	15
1854	208.5	40	29	59.5	20	M8	130	174	137	154	127	181	113.5	80	120-106	6.5	151	13.5	44	10	15
2254	208.5	48	17	47.5	25	M10	130	197	137	172	127	181	113.5	80	120-106	6.5	151	20.5	44	10	15
2654	244.5	48	34	66.5	25	M10	147	203	145	178	147	213	141	96	120-106	6.5	186	20.5	38	10	15
3304	261	48	43	74	25	M10	147	206	145	181	158	219	145	96	120-106	6.5	202.5	20.5	38	10	15
4004	261	48	43	74	25	M10	151	206	209	181	158	219	145	80(66-102)	180	8.5	170(156-192)	23.5	67.5	15	20
5004	288	55	46	77	30	M10	169	238	209	208	172	232	146	140(66-175)	180	8.5	230(156-265)	23.5	34.5	15	20
6304	389	80	60	89	40	M12	201	304	280	264	202	255	155	240(150-275)	180	10.5	---	60.5	68.5	20	30
8004	389	80	60	89	40	M12	201	304	280	264	202	255	155	240(150-275)	180	10.5	---	60.5	68.5	20	30

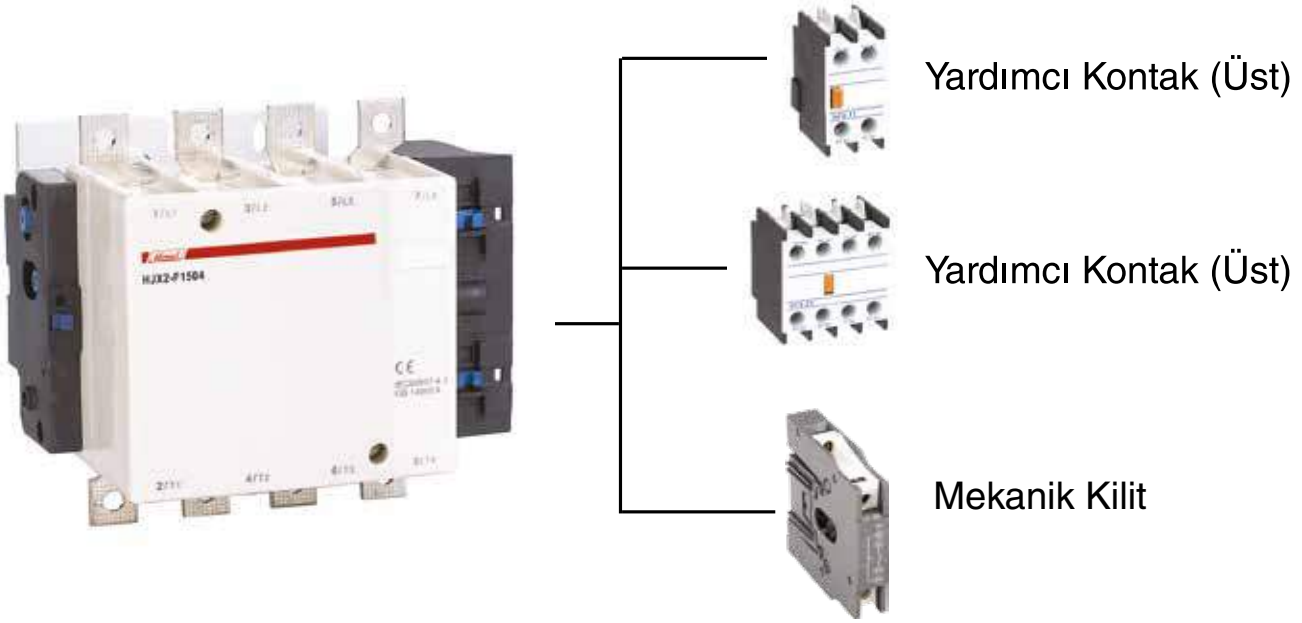

Yardımcı Kontak (Üst)

Yardımcı Kontak (Üst)

Mekanik Kilit



Referans	Açıklama	Birim Fiyat (₺)	Kutu (Adet)	Koli (Adet)
HF440	Üstten Yardımcı Kont. 4NO (9A~630A)	138,00	6	102
HF431	Üstten Yardımcı Kont. 3NO 1NC (9A~630A)	138,00	6	102
HF422	Üstten Yardımcı Kont. 2NO 2NC (9A~630A)	138,00	10	170
HF413	Üstten Yardımcı Kont. 1NO 3NC (9A~630A)	138,00	6	102
HF404	Üstten Yardımcı Kont. 4NC (9A~630A)	138,00	6	102
HF411	Üstten Yardımcı Kont. 1NO 1NC (9A~630A)	95,00	10	170
HF420	Üstten Yardımcı Kont. 2NO (9A~630A)	91,00	10	170
HF402	Üstten Yardımcı Kont. 2NC (9A~630A)	95,00	10	170
HFR632H	Mekanik Kilit (9A~25A)	228,00	1	60
HFR695HX	Mekanik Kilit (40A~95A)	300,00	1	60
HFR6FFHs	Mekanik Kilit (115A~150A)	228,00	1	60
HFR6GGHs	Mekanik Kilit (185A~225A)	228,00	1	60
HFR6HHHs	Mekanik Kilit (265A~330A)	228,00	1	60
HFR6KKHs	Mekanik Kilit (400A~500A)	228,00	1	60
HFR6LLHs	Mekanik Kilit (630A~800A)	228,00	1	60

Mini Kontaktör 220/24 V AC 50/60 Hz (3 Kutup)

Himel

Reliable made affordable.



Anma Gücü (380/400 V kW)	Anma Akımı (A)	Referans 220V AC	Yard. Kontak	Birim Fiyat (₺)	Kutu (Adet)	Koli (Adet)
2.2 kW	6A	HDC17K63010M7	1NO	230,00	1	144
2.2 kW	6A	HDC17K63001M7	1NC	230,00	1	144
4 kW	9A	HDC17K93010M7	1NO	256,00	1	144
4 kW	9A	HDC17K93001M7	1NC	256,00	1	144
5.5 kW	12A	HDC17K123010M7	1NO	275,00	1	144
5.5 kW	12A	HDC17K123001M7	1NC	275,00	1	144

Anma Gücü (380/400 V kW)	Anma Akımı (A)	Referans 24 V AC	Yard. Kontak	Birim Fiyat (₺)	Kutu (Adet)	Koli (Adet)
2.2 kW	6A	HDC17K63010B7	1NO	230,00	4	144
2.2 kW	6A	HDC17K63001B7	1NC	230,00	4	144
4 kW	9A	HDC17K93010B7	1NO	256,00	4	144
4 kW	9A	HDC17K93001B7	1NC	256,00	4	144
5.5 kW	12A	HDC17K123010B7	1NO	275,00	4	144
5.5 kW	12A	HDC17K123001B7	1NC	275,00	4	144

Referans	Açıklama	Birim Fiyat (₺)	Kutu (Adet)	Koli (Adet)
HF4K11	Üstten Yardımcı Kont. 1NO 1NC	119,00	1	378
HF4K20	Üstten Yardımcı Kont. 2NO	119,00	1	378
HF4K02	Üstten Yardımcı Kont. 2NC	119,00	1	378
HF4K22	Üstten Yardımcı Kont. 2NO 2NC	144,00	1	378

Kompanzasyon Kontaktörleri 220V AC 50/60 Hz (3 Kutup)



Çalışma Gücü Kvar 400 V50Hz	Yardımcı Kontak	Anma Akımı (A)	Referans	Birim Fiyat (₺)	Kutu (Adet)	Koli (Adet)
12	1NO 1NC	25A	HDC19s2511M7	686,00	1	20
20	1NO 1NC	32A	HDC19s3211M7	866,00	1	16
25	1NO 1NC	43A	HDC19s4311M7	1.276,00	1	16
30	2NO 1NC	63A	HDC19s6321M7	1.908,00	1	8
50	2NO 1NC	95A	HDC19s9521M7	2.527,00	1	8

Teknik Özellikler

Model	HDC19s-25	HDC19s-32	HDC19s-43	HDC19s-63	HDC19s-95		
Ana Devre							
Anma İşletme Gerilimi	V				380 - 400		
Anma İzolasyon Gerilimi	V				690		
Uygulanacak Kapasitör Değeri	380V, AC-6b	A	17	29	36	43	72
Uygulanacak Kapasitör Değeri	230V, AC-6b	Kvar	6	10	15	18	30
	400V, AC-6b	Kvar	12	20	25	30	50
Konvensiyonel Termik Akımı	A		25	32	43	63	95
Uygulanacak Maks. Akım Kapasitesi			≤ 35 in			≤ 55 in	
Mekanik Ömür		× 10 ⁴ Aç-Kapa			100		
Elektriksel Ömür	380V, AC-6b	× 10 ⁴ Aç-Kapa	15				12
İşletme Frekansı	400V, AC-6b	Çalışma/Saat	300				120
İletken Ölçüleri		mm ²	4				
Bobin							
Bobin Gerilimi (Us)	V		110, 127, 220/230, 240, 380/400, 415, 440				
Devrede Gerilim Aralığı	V		85%~110%Us				
Devre Dışı Gerilim Aralığı	V		20%~75%Us				
Bobin Frekansı	Hz		AC 50 Hz & 50/60 Hz				



Anma Kontrol Gücü (kW)	Ayar Sahası	Referans	Birim Fiyat (₺)	Kutu (Adet)	Koli (Adet)
0,09 kW	0.25~0.4A	HDP632P4	664,00	1	60
0,12 kW	0,4~0.63A	HDP632P63	664,00	1	60
0,25 kW	0,63~1A	HDP6321	664,00	1	60
0,37 kW	1~1.6A	HDP6321P6	664,00	1	60
0,75 kW	1.6~2.5A	HDP6322P5	688,00	1	60
1,5 kW	2.5~4A	HDP6324	688,00	1	60
2,2 kW	4~6.3A	HDP6326P3	694,00	1	60
4,0 kW	6~10A	HDP63210	694,00	1	60
5,5 kW	9~14A	HDP63214	727,00	1	60
7,5 kW	13~18A	HDP63218	727,00	1	60
9,0 kW	17~23A	HDP63223	763,00	1	60
11,0 kW	20~25A	HDP63225	763,00	1	60
15,0 kW	24~32A	HDP63232	763,00	1	60
16,0 kW	25-40A	HDP17Z8040	2.258,00	1	30
20,0 kW	40-63A	HDP17Z8063	2.258,00	1	30
25,0 kW	56-80A	HDP17Z8080	2.258,00	1	30

Teknik Özellikler

İşletme Modu	Buton	Bağlantı Tork	1.7N m
Kasa Akımı	32A	Mekaniksel Ömür	100000
Anma Darbe Dayanım Gerilimi	6000V	Elektriksel Ömür AC-3 400V	100000
Anma İşletme Gerilimi	690V	Aşırı Yük Koruma Kategorisi	Faz Koruma, Termik Koruma
Anma İzolasyon Gerilimi	690V	Kısa Devre Koruma	Evet
Anma İşletme Frekansı	50/60Hz	İzolasyon	Evet
Açma Sınıfı	10A	Sıcaklık Kompanze	Evet

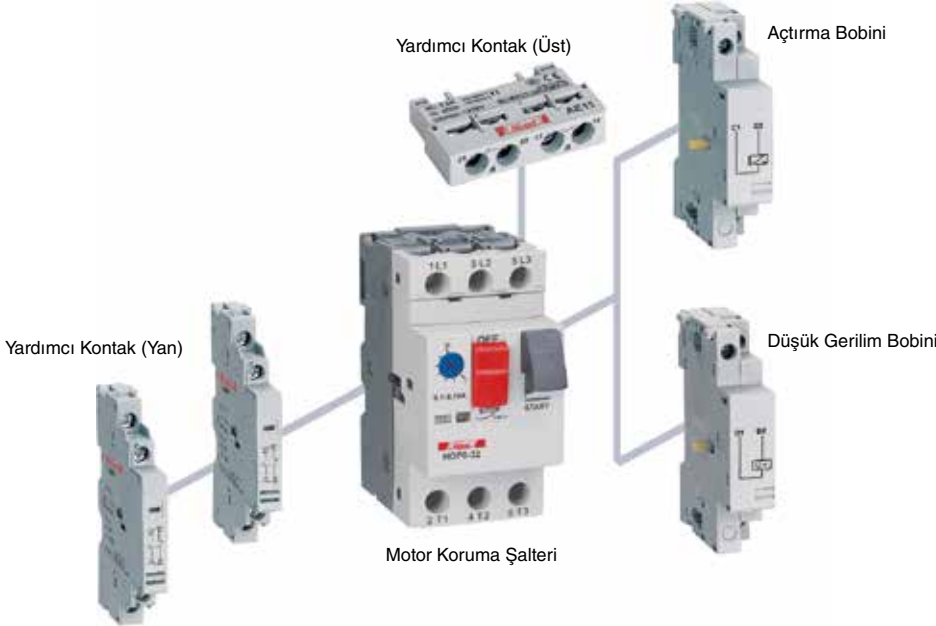



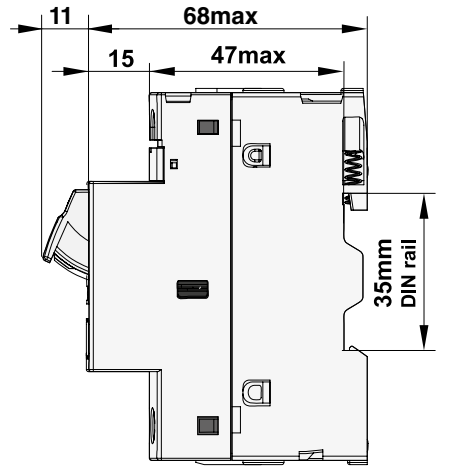



Boyutlar

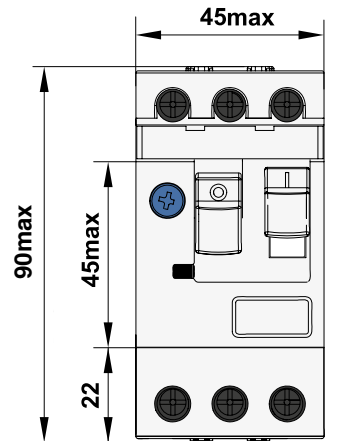

Aksesuarlar

Referans	Açıklama	Birim Fiyat (₺)	Kutu (Adet)	Koli (Adet)
HAU220	Düşük Gerilim Bobini 220~240V	292,00	2	48
HAS220	Açırma Bobini 220~240V	292,00	2	48
HAE20	Yardımcı Kontakt (Üst) 2A Kontakt	91,00	40	320
HAE11	Yardımcı Kontakt (Üst) 1A+1K Kontakt	91,00	40	320
HAN20	Yardımcı Kontakt (Yan) 2A Kontakt	238,00	4	96
HAN11	Yardımcı Kontakt (Yan) 1A+1K Kontakt	181,00	4	96
HDP632MC	Muhafaza Kutusu IP55	246,00	1	5
HDP17Z80A02	HDP17 - Yardımcı Kontakt (Yan) 2A Kontakt	234,00	10	150
HDP17Z80A01	HDP17 - Yardımcı Kontakt (Yan) 1A+1K Kontakt	234,00	10	150



	Referans	Ürün Adı	Birim Fiyat (₺)	Kutu (Adet)	Koli (Adet)
Yaylı Butonlar					
	HLAY5EA42	1NK Yaylı Buton - Kırmızı	45,00	10	200
	HLAY5EA21	1NA Yaylı Buton - Siyah	45,00	10	200
	HLAY5EA31	1NA Yaylı Buton - Yeşil	45,00	10	200
	HLAY5EA51	1NA Yaylı Buton - Sarı	45,00	10	200
	HLAY5EA61	1NA Yaylı Buton - Mavi	45,00	10	200
	HLAY5EC42	Mantar Kafa Yaylı Buton 40 mm 1 NK - Kırmızı	66,00	10	160
	HLAY5EC45	Mantar Kafa Yaylı Buton 40 mm 1NA + 1NK - Kırmızı	84,00	10	160
	HLAY5EW84M5L	1NA + 1NK İkiz Buton	120,00	10	160
Acil Durdurma Butonları					
	HLAY5ES542	Acil Durdurma Butonu 40 mm Tetiklemeli Kilitli 1NK - Kırmızı	75,00	10	160
	HLAY5ES545	Acil Durdurma Butonu 40 mm Tetiklemeli Kilitli 1NA+1NK - Kırmızı	99,00	10	160
Mandal Butonlar					
	HLAY5ED21	1NA Mandal Buton - 2 Konumlu	61,00	10	160
	HLAY5ED33	2NA Mandal Buton - 3 Konumlu	84,00	10	160
	HLAY5ED41	1NA Mandal Buton - 2 Konumlu Reset	61,00	10	160
	HLAY5ED53	1NA Mandal Buton - 3 Konumlu Reset	66,00	10	160
Kilitli Butonlar					
	HLAY5EG21	1NA Kilitli buton - 2 Konumlu	153,00	10	160
	HLAY5EG33	2NA Kilitli Buton - 3 Konumlu Reset	183,00	10	160
Işıklı Yaylı Butonlar					
	HLAY5EW33M5L	Led Işıklı Buton 220 V 1NA+1NK - Yeşil	104,00	10	160
	HLAY5EW34M5L	Led Işıklı Buton 220 V 1NA+1NK - Kırmızı	104,00	10	160
	HLAY5EW35M5L	Led Işıklı Buton 220 V 1NA+1NK - Sarı	104,00	10	160
	HLAY5EW36M5L	Led Işıklı Buton 220 V 1NA+1NK - Mavi	104,00	10	160
	HLAY5EW31M5L	Led Işıklı Buton 220 V 1NA+1NK - Beyaz	104,00	10	160
	HLAY5EW33B5L	Led Işıklı Buton 24 V 1NA+1NK - Yeşil	104,00	10	160
	HLAY5EW34B5L	Led Işıklı Buton 24 V 1NA+1NK - Kırmızı	104,00	10	160
	Kontakt Blokları				
	HLAY5BE101	1 NA Kontakt	27,00	25	500
	HLAY5BE102	1 NK Kontakt	27,00	25	500
Led'li Sinyal Lambaları					
	HLD1122D41M3	Sinyal Lambası AC 220V - Yeşil	45,00	12	360
	HLD1122D41M4	Sinyal Lambası AC 220V - Kırmızı	45,00	12	360
	HLD1122D41M5	Sinyal Lambası AC 220V - Sarı	45,00	12	360
	HLD1122D41M8	Sinyal Lambası AC 220V - Mavi	45,00	12	360
	HLD1122D41M7	Sinyal Lambası AC 220V - Beyaz	45,00	12	360
	HLD1122D21B3	Sinyal Lambası AC.DC 24V - Yeşil	45,00	12	360
	HLD1122D21B4	Sinyal Lambası AC.DC 24V- Kırmızı	45,00	12	360
	HLD1122D21B5	Sinyal Lambası AC.DC 24V - Sarı	45,00	12	360
HLD1122D21B8	Sinyal Lambası AC.DC 24V - Mavi	45,00	12	360	

HİMEL TÜRKİYE SATIŞ

GENEL MERKEZ

Himel Elektrik Malz. Tic. A.Ş.

Küçükbakkalköy Mah. Defne Sok.
No:3 Özel İşyeri No:20
Ataşehir / İstanbul
Tel.: 0216 574 33 00
Faks: 0216 574 33 01
info@himel.com
www.himel.com/tr

İzmir İrtibat:

Tel.: 0232 486 50 80
Faks: 0232 486 30 50
Gsm: 0534 654 28 90
info@himel.com
www.himel.com/tr

Ankara İrtibat:

Gsm: 0533 742 52 19
info@himel.com
www.himel.com/tr

Trabzon İrtibat:

Gsm: 0539 593 80 14
info@himel.com
www.himel.com/tr

İŞ ORTAKLARIMIZ

ADANA

Olca Elektrik Ltd. Şti.

Karasoku Mah. 28026 Sok.
No:7/B Seyhan/Adana
Tel: 0322 352 88 76
Fax: 0322 359 89 60
olcay@olcayelektrik.com
www.olcayelektrik.com

DİYARBAKIR

Voltam Ticaret

Diyarbakır 1. San. Sit.
18. Kısım No:11 Diyarbakır
Tel: 0412 223 83 12
Fax: 0412 223 07 15
voltamticaret@gmail.com
www.voltamticaret.com

Uzman Elektrik Ltd. Sti.

Merkez:

Halkalı Caddesi Erk İş Merkezi
No: 190/53-55
Sefaköy - K.Çekmece / İstanbul
Tel: 0212 472 71 05 (Pbx)
Fax: 0212 472 71 01
info@uzman-elektrik.com.tr
www.uzman-elektrik.com.tr

KONYA

Günay Otomasyon

Fevzi Çakmak Mah. Medcezir Cad.
B Blok No:8/1 Karatay / Konya
Tel: 0332 345 03 13
Fax: 0332 345 03 13
gcalik042@hotmail.com
gunayotomasyon4242@gmail.com

ANKARA

HFM Elektrik Ltd. Şti.

İvedik Osb 1467. Cad.
Ankara Elektrokent İş Mrkz. No:2/8
Ostim - Yenimahalle / Ankara
Tel: 0312 395 25 45 (pbx)
Fax: 0312 395 25 85
info@hfm.com.tr
www.hfm.com.tr

İSTANBUL

Anka Mühendislik Merkez:

Ferhatpaşa Mah. G-12 Sk.
No:13 Ataşehir / İstanbul
Tel: 0216 660 16 16 (Pbx)
Fax : 0216 660 03 09
info@ankamuh.com
www.ankamuh.com

İkitelli Şube:

Ziya Gökalp Mah.
Bedrettin Dalan Bulvarı
Aykosan Ayk. Sit. Çarşı B Blok
VIP Plaza No: 1/11
İkitelli Osb Başakşehir / İstanbul
Tel: 0216 660 16 16
Fax: 0216 660 03 09
info@ankamuh.com
www.ankamuh.com

Perpa Şube:

Perpa Ticaret Merkezi
A Blok kat:5 No:143
Şişli/İstanbul
Tel: 0212 472 71 06
perpa@uzman-elektrik.com.tr
www.uzman-elektrik.com.tr

Botek Otomasyon

Aslım Caddesi Kobisan-1 Sanayi Sitesi
69/H Karatay / KONYA
Tel: 0332 502 35 41
botek@botekotomasyon.com
www.botekotomasyon.com

Aven Endüstriyel Elektrik Ltd. Şti.

İvedik OSB Mahallesi
1378. Sokak No:8
Ostim - Yenimahalle / ANKARA
Tel: 0312 394 49 84
satis@avenelektrik.com
www.avenelektrik.com

İZMİR

Elektromak Elektrik Ltd. Şti.

1263 Sk. No:13/A
Yenişehir, Konak / İzmir
Tel: 0232 459 39 59
Fax: 0232 433 55 95
info@elektromakltd.com.tr
www.elektromakltd.com.tr

TRABZON

Akım Elektrik Ltd. Şti.

Kaymaklı Mah. Anadolu Bulvarı
No:98 Ortahisar / Trabzon
Tel: 0462 325 19 19
info@akimelektrik.net
www.akimelektrik.net

ANTALYA

Botek Otomasyon

Yeniğün Mah. Yunus Emre Cad.
No: 93/B Muratpaşa / Antalya
Tel : 0242 312 11 13
botek@botekotomasyon.com
www.botekotomasyon.com

Soylu Otomasyon

Merkez:

Aykosan San.Sit.Yolu Çarşı
Blok No:193 Başakşehir / İstanbul
Tel: 0212 671 33 56
Fax: 0212 671 33 60

Karaköy Şube:

Bereketzade Mah. Okçumusa Cad.
Yücel Han No:13 Kat:1
34421 Karaköy / İstanbul
Tel: 0212 251 71 10
Fax: 0212 251 71 35

Hadımköy Şube:

Çakmaklı Mah. İnkılap Sk. No: 3
Büyükkçekmece / İstanbul
Tel: 0212 886 90 54
Fax: 0212 886 45 31
info@soyluotomasyon.com
www.soyluotomasyon.com

Geotek Otomasyon

Halkapınar Mah. 1345 Sokak No:4/A
Boran Plaza Konak / İzmir
Tel: 0232 433 47 80
Fax: 0232 433 47 81
satis@geotekotomasyon.com
www.geotekotomasyon.com

BURSA

Botek Otomasyon

Alaattin Bey Mah. 632. Sok.
No:6/B Nilüfer / Bursa
Tel : 0224 441 18 60
botek@botekotomasyon.com
www.botekotomasyon.com

PANO İŞ ORTAKLARIMIZ

ANTALYA

Kontak Enerji Pano

Şafak Mah. 4261 Sok.Elegant Plaza İş Merkezi
No:4/26 Kepez / Antalya
Tel: 0554 209 98 26
Fax: 0242 408 32 16
kontakenerji@gmail.com
www.kontakenerji.com

TRABZON

3K Group Pano

Sanayi Mah. Şamdan Sk.
No:16 Ortahisar / Trabzon
Tel: 0462 332 15 15
muhasbe@3kpano.com.tr





YETKİLİ SATICI

Himel Elektrik Malzemeleri Tic. A.Ş.

Küçükbakkalköy Mah.Defne Sok.No:3
Özel İşyeri No:20 Ataşehir/İSTANBUL
Tel : 0216 574 33 00
Faks : 0216 574 33 01
info@himel.com

www.himel.com/tr

[/himel.elektrik](https://www.facebook.com/himel.elektrik)



Haziran 2022

Reliable made affordable.